

# LOGIK

## 22" HD Ready 1080p Digital LCD TV With DVD Player

Instruction Manual  
L22DVDB10



# Contents

<b>Preparation</b> .....	<b>4</b>
Unpacking the TV .....	4
Installing / Removing the Base Stand .....	5
Front / Top / Side View and Controls .....	6
Rear View and Sockets .....	7
Installing Batteries in the Remote Control .....	8
Remote Control Operation Range.....	8
Remote Control .....	9
<b>Connections</b> .....	<b>12</b>
Making Video and Audio Connections.....	12
Connecting an AV Device with HDMI Cable .....	12
Connecting a Computer with VGA Cable .....	13
Connecting an AV Device with Component (YPbPr) Cable .....	13
Connecting an AV Device with SCART Cable .....	14
Connecting an AV Device with S-Video Cable.....	14
Connecting an AV Device with Composite Cable.....	15
Connecting a Coaxial Audio Receiver .....	15
Connecting Earphones.....	16
Connecting a USB Storage Device.....	16
Connecting the Aerial .....	17
<b>Initial Setup</b> .....	<b>17</b>
Turning the TV On for the First Time .....	17
– Selecting the Input Source.....	18
– Channel Selection .....	18
– Volume Adjustment.....	18
<b>Using the Features</b> .....	<b>19</b>
Customising the PICTURE Setting .....	19
– Picture Mode .....	19
Customising the SOUND Setting .....	20
– Sound Mode .....	20
– Stereo / Dual Sound Reception (TV Mode) .....	20
– Speaker Sound Output Selection (DTV Mode) .....	20
Customising the FUNCTION Setting.....	21
– Video Size .....	21
– TT Language.....	22
– Sleep Timer .....	22
– OSD Timer.....	23
– Blue Screen .....	23
– Child Lock .....	23
– Key Locked .....	24
– Reset .....	25
– Installation.....	25
Customising the TV Setting (TV Mode) .....	26
– Country.....	26
– Auto Tuning .....	26
– Manual Tuning.....	27
– Channel Edit .....	27
Customising the TV Settings (DTV Mode) .....	28
– Auto Tuning .....	28
– Manual Tuning .....	29
– Channel Edit .....	29
– Timer .....	30
– Rating.....	30
– CI (Common Interface) (DTV Mode).....	31

Customising the TV Settings (PC Mode) .....	32
Customising the TV Settings (HDMI and YPbPr Modes).....	32
Teletext (TV Mode) .....	33
– To Turn on Teletext Function.....	33
Digital Teletext (DTV Mode).....	34
– Teletext within Digital Service.....	34
EPG (Electronic Programme Guide) (DTV Mode) .....	34
– Switch On/Off EPG.....	34
– Select a Programme .....	34
<b>Using the Features via USB Port .....</b>	<b>35</b>
My Album.....	35
My Music .....	36
My Movie.....	36
My Recorder.....	37
– Recorded List.....	37
– Recording Device.....	38
– Recording Preference.....	39
<b>DVR (Digital Video Recorder).....</b>	<b>40</b>
Time Shift Function.....	40
– Auto Time Shift Mode.....	40
– Pause Time Shift Mode .....	40
Recording DTV Programme onto a USB Storage Device .....	41
Timer Programming .....	42
Using the Built-in DVD Player .....	43
Compatible Disc Types .....	43
– Supported Formats.....	43
– Region Code.....	43
<b>Using the DVD Features.....</b>	<b>43</b>
Basic DVD Playback Functions.....	44
– Playing the DVD .....	44
– Menu Playback (for DVD) .....	44
– Stopping Playback.....	44
– Previous / Next (for DVD / CD / Multimedia discs) .....	44
– Forward / Backward (for DVD / CD / Multimedia discs).....	44
– Pause (for DVD / CD / Multimedia discs) .....	44
– Repeat (for DVD / CD / Multimedia discs).....	44
– Info (for DVD / CD / Multimedia discs) .....	45
– Goto (for DVD / CD / Multimedia discs).....	45
– Audio (for DVD / CD).....	45
– Repeat A-B (for DVD / CD).....	45
Playing Multimedia Discs.....	45
Using the DVD System Setup Page .....	46
Using the DVD Language Setup Page.....	47
Using the DVD Audio Setup Page.....	48
Using the DVD Speaker Setup Page.....	49
Using the DVD Dolby Digital Setup Page .....	49
<b>Maintenance .....</b>	<b>50</b>
<b>Hints and Tips .....</b>	<b>51</b>
<b>Display Modes .....</b>	<b>53</b>
YPbPr Mode .....	53
PC Mode.....	53
HDMI Mode .....	53
<b>Specification.....</b>	<b>54</b>
<b>Safety Warnings .....</b>	<b>55</b>

## Congratulations

 on the purchase of your new Logik TV.

Your new TV has many features and incorporates the latest technology to enhance your viewing experience. We recommend that you spend some time reading this instruction manual in order that you fully understand these features. You will also find some hints and tips to help you resolve any issues.

Read all the safety instructions carefully before use and keep this instruction manual for future reference.

## Unpacking the TV

Remove all packaging from the TV. Retain the packaging. If you dispose of it please do so according to local regulations.

The following items are included:

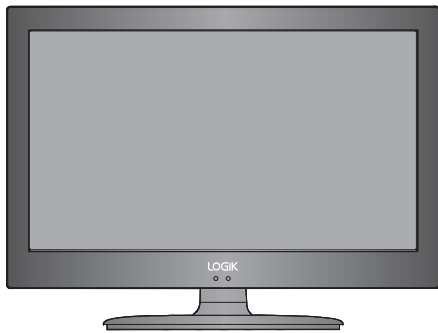

TV with TV Base  
TV Base's part number: **I.01.526302031**

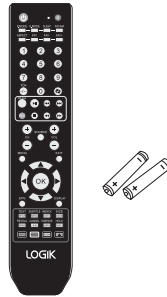

Remote Control / AAA Batteries x 2  
part number **I.14.00000589** and  
**E.17.101570001**

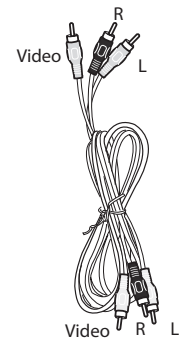

AV Cable  
part number **E.14.113150013**



Instruction Manual  
part number **I.08.015229001**

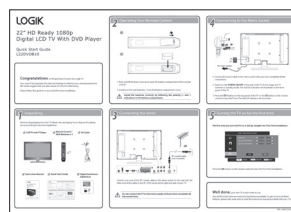

Quick Start Guide  
part number **I.08.035229002**

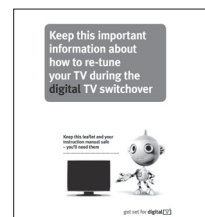

Digital TV Switchover Addendum  
part number **I.08.035197804**



If items are missing, or damaged please contact Partmaster (UK only). Tel: 0870 6001 338 for assistance.

## Installing / Removing the Base Stand



Remove the base stand before mounting the TV onto the wall. The LCD display is very fragile, and must be protected at all times when installing and removing the base stand. Be sure that no hard or sharp object, or anything that could scratch or damage the LCD display, comes into contact with it. DO NOT exert pressure on the front of the TV at any time because the screen could crack.

1. Disconnect all cables connected to the TV.
2. Lay the TV down on a flat surface with the back side facing up. Please make sure to place a soft cushioned material (such as a pillow or thick piece of foam) beneath the screen.
3. To remove the base stand, untighten the 4 screws that hold the base stand to the rear of the TV.



Keep all the spare screws should you want to use the base stand option.

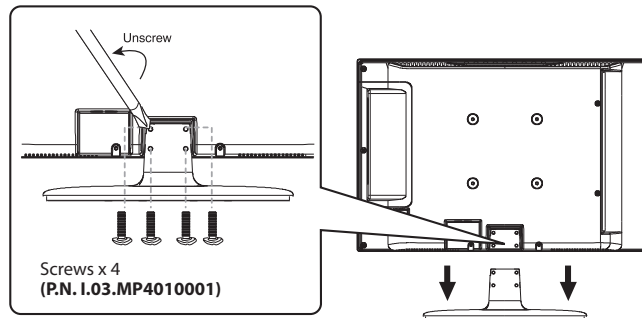

4. Mounting on the wall. This TV is designed to be wall-mounted with a standard 100 mm x 100 mm mounting kit designed for flat-panel TVs (sold separately). Mount this TV according to the instructions included in the mounting kit. Due to the space restriction, we recommend you to make all connections (refer to page 12-17 for details) before final mounting on the wall.

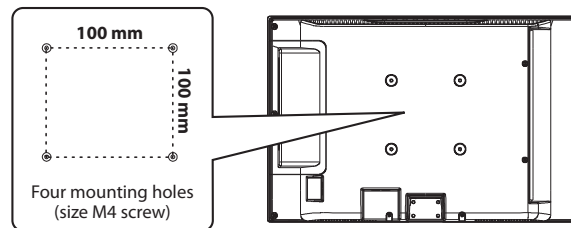

5. To re-install the base stand, reattach the base stand with the 4 screws.

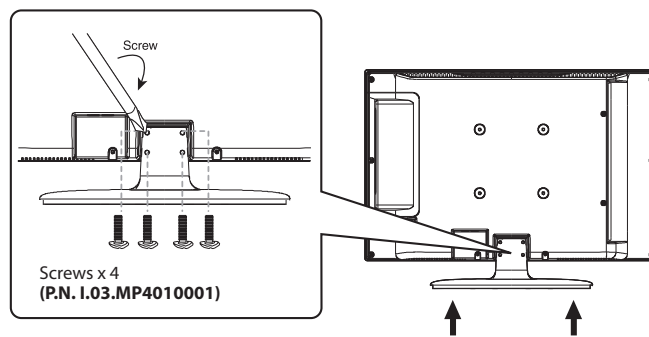

If items are missing, or damaged please contact Partmaster (UK only). Tel: 0870 6001 338 for assistance.

## Front / Top / Side View and Controls

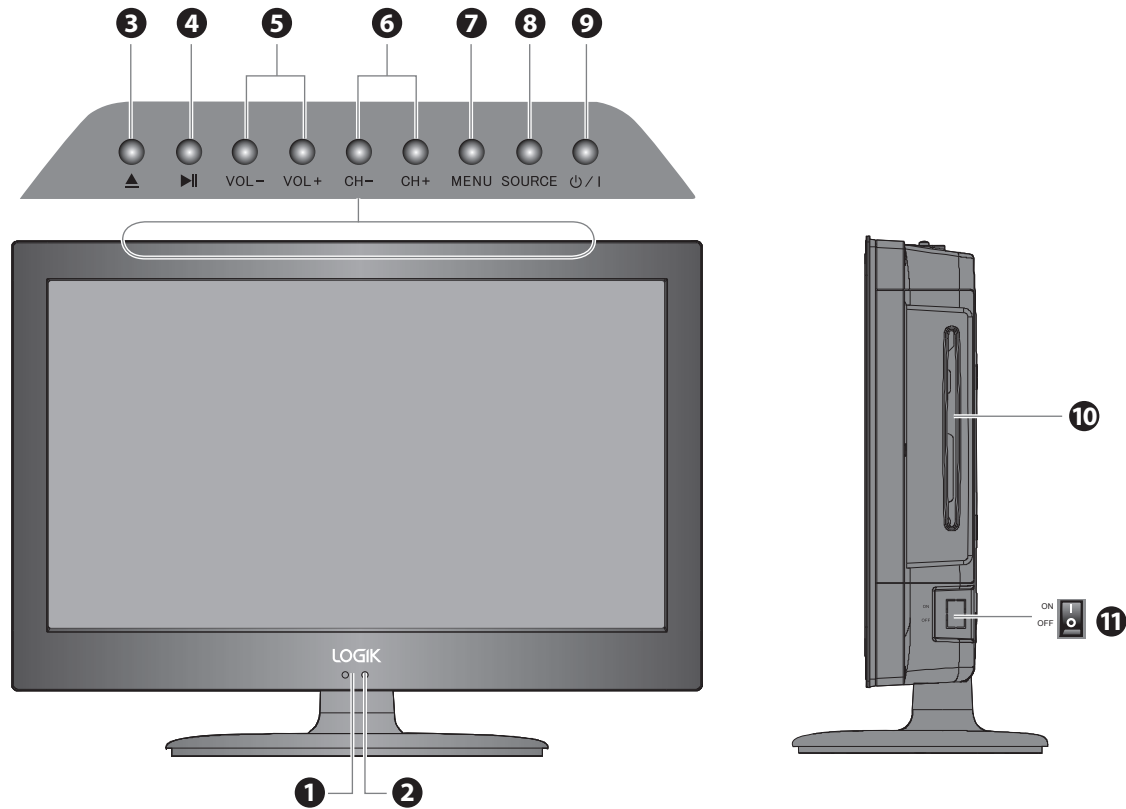

Item	Description
<b>1 POWER LED</b>	Illuminates blue when the TV is turned on. Illuminates red when the TV is in standby mode. The LED will illuminate blue when the timer programming has started in the standby mode.
<b>2 IR (Infrared Receiver)</b>	Receives IR signals from the remote control. Do not put anything near the sensor, as its function may be affected.
<b>3 ▲</b>	Press to insert and eject disc. (DVD mode)
<b>4 ►  </b>	Press to start playback or pause. (DVD mode)
<b>5 VOL +/-</b>	Adjust the volume. Select and adjust a setting in the OSD menus.
<b>6 CH +/-</b>	Select a channel. Select a sub-menu of the OSD menu.
<b>7 MENU</b>	Displays the OSD (on screen display) menu.
<b>8 SOURCE</b>	Select among the different input signal sources: DTV / TV / DVD / AV / S-VIDEO / SCART / YPBPR / HDMI / PC
<b>9 ⏻ / I</b>	Switch the TV on from standby. Switch the TV back to standby.
<b>10 Disc Slot</b>	Insert the disc with the mirror side facing towards you (12 cm discs only. Don't insert 8 cm discs)
<b>11 POWER ON/OFF</b>	Switch on the <b>POWER ON/OFF</b> switch to turn the TV to standby mode.

# Rear View and Sockets

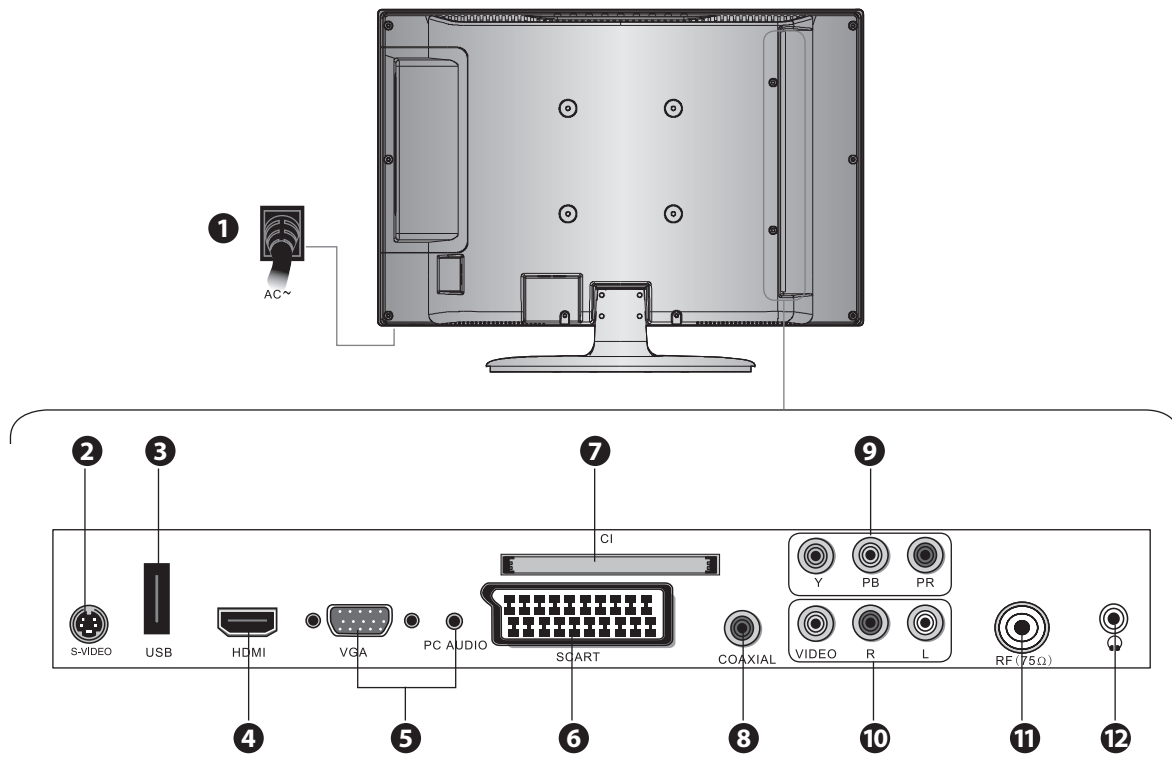

Item	Description
1 AC~	Connect the mains cable to the mains socket.
2 S-VIDEO	Connect to a VCR, DVD Player, or other AV devices with S-Video output sockets.
3 DVR USB port	Allows the insertion of a USB storage device. You can view media files or record DTV programmes through this port. (Media Mode)
4 HDMI	HDMI (High-Definition Multimedia Interface) provides an uncompressed, all digital audio/video interface between this TV and any HDMI-device, such as a set-top box, Blu-ray player, and AV receiver.
5 VGA / PC AUDIO	Connect to a computer or other devices with a VGA interface.
6 SCART	Connect to a VCR, DVD Player, or other AV devices with SCART output socket.
7 CI (Common Interface) Slot	Allows the insertion of a Common Access Module. (Refer to page 31 for details.)
8 COAXIAL	Connect to the audio socket on the digital/standard 5.1 audio system.
9 Y, PB, PR	Connect to a DVD player, Digital Set-Top-Box, or other AV devices with component (YPbPr) video and audio output sockets.
10 VIDEO / AUDIO (L/R)	Connect to the Composite VIDEO and AUDIO (L/R) output sockets on external video devices.
11 RF (75 Ω)	Connect to the aerial socket on the wall with the RF coaxial cable.
12 🎧	Connect earphones for private listening.

## Installing Batteries in the Remote Control

1. Press and lift the back cover up to open the battery compartment of the remote control.
2. Insert two AAA size batteries. Make sure to match the (+) and (-) ends of the batteries with the (+) and (-) ends indicated in the battery compartment.
3. Close the battery compartment cover.

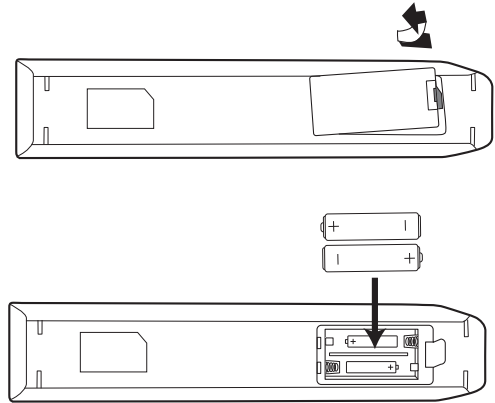

### Handling the Batteries

- Improper or incorrect use of batteries may cause corrosion or battery leakage, which could cause fire, personal injury or damage to property.
- Only use the battery type indicated in this manual.
- When the batteries are exhausted, the remote will not function. Replace both batteries at the same time with new ones.
- Do not install new batteries with used ones and do not mix different types of batteries.
- Do not dispose of used batteries as domestic waste. Dispose of them in accordance with local regulations.



### Handling the Remote Control

- Take care of your fingernails when you press and hold the battery release tab.
- Do not drop or cause impact to the remote control.
- Do not spill water or any liquid on the remote control.
- Do not place the remote control on a wet object.
- Do not place the remote control under direct sunlight or near sources of excessive heat.
- Remove the battery from the remote control when not in use for a long period of time, as it could cause corrosion or battery leakage and may result in physical injury and/or property damage including fire.





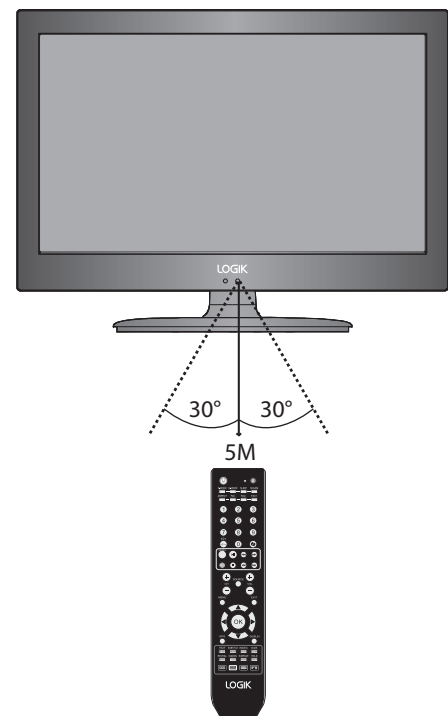

## Remote Control Operation Range

Point the remote control at the TV no more than 5 metres from the remote control sensor on the TV and within 60° in front of the TV. The operating distance may vary depending on the brightness of the room.





# Remote Control

- 1 Transmission Indicator**  
Illuminates red when you press a button.
- 2**   
Switch the TV between on and standby mode.
- 3**   
Mute and restore your TV sound.
- 4 P.MODE**  
Selects picture mode: Personal / Standard / Movie / Mild / Game.
- S.MODE**  
Selects sound mode: Standard / Music / Voice / Theatre / Personal.
- 5 ASPECT**  
Select from the following modes settings: Auto / Full / 4:3 / 14:9 / Zoom.
- 6 SLEEP**  
Set the TV sleep timer.
- NICAM**  
Switch between different audio languages (only applicable when the TV programme has this feature).
- 7 FAV**  
Display the Favourite Channel List.
- FAV +/-**  
Switch between your favourite channels.
- 8 0-9 Number Button**  
Select a programme.  
Select numbered items in a menu.
- 9 -/--**  
Select and switch to a channel that is higher than Channel 9. (TV mode)
- 10+**  
For example: for track 23, press 10+ twice followed by 3. (DVD mode)
- 10**   
Return to previous viewing channel.
- 11 MEDIA**  
Enter the Multimedia Setup Menu.
- 12 REC**  
One button recording function button. Press it to record the current DTV video.
- 13**   
Press to start playback or pause. (Media / DVD mode)
-   
Press to stop playback. (Media / DVD mode)
-   
Press to skip to the beginning of the previous / next chapter or track. (Media / DVD mode)
-   
Use to advance or reverse playback rapidly. (Media / DVD mode)

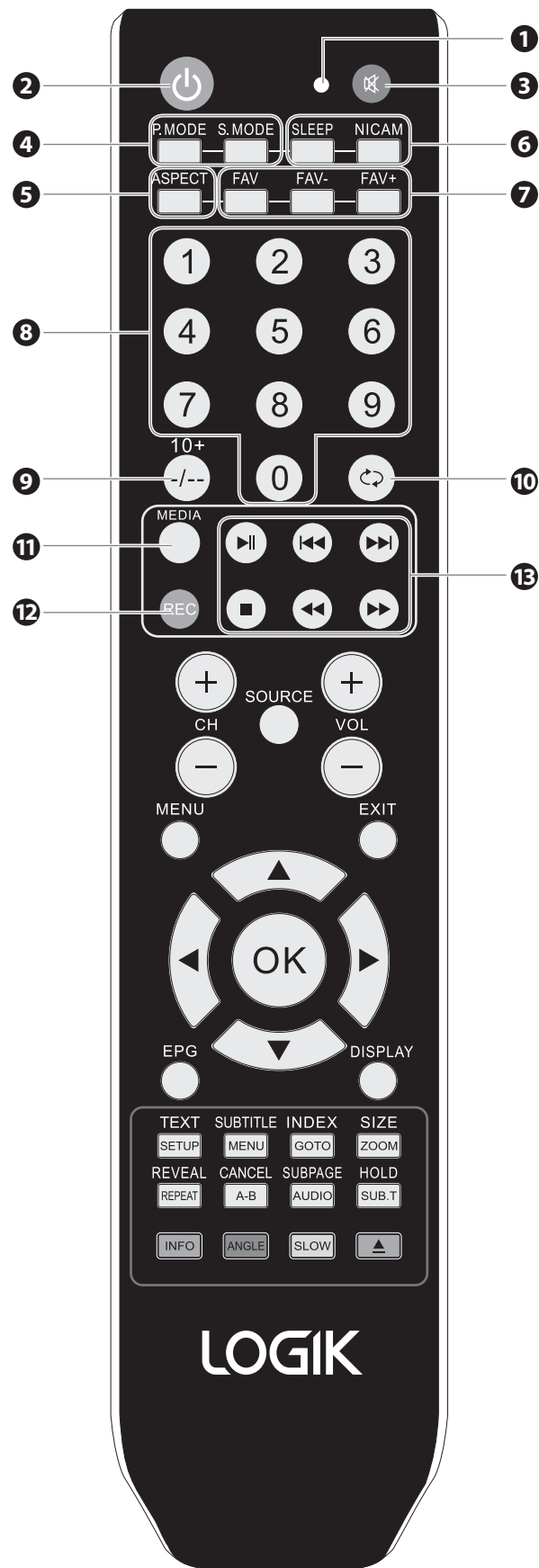



**26 REVEAL**

Reveal hidden information such as the answer to a quiz in Teletext. (TV mode)

**REPEAT**

Repeat a title, chapter, track or whole disc. (DVD mode)

**27 CANCEL**

To cancel the teletext mode completely. (TV mode)

**A-B**

Repeat a segment between A and B. (DVD mode)

**28 SUBPAGE**

Display the subpage on the teletext screen. (TV mode)

**AUDIO**

Change the audio language or audio channel. (DVD mode)

**29 HOLD**

Freeze a multi-page passage on screen in Teletext. (TV mode)

**SUB.T**

Display subtitle in the DVD. (DVD mode)

**30 Coloured buttons**

Access the TELETEXT items or programme edit when using Digital / Freeview TV Channels. (TV / DTV / DVD mode)

**INFO** (red)

Display information. (DVD mode)

**ANGLE** (green)

Select different angles for the video. (DVD mode)

**SLOW** (yellow)

Select slow speed playing and resume normal play. (DVD mode)

**▲** (blue)

To insert and eject disc. (DVD mode)













## Making Video and Audio Connections

Not all AV devices have the ability to connect to a TV, please refer to the owner's manual of your AV device for compatibility and connection procedures.

When connecting any external AV device, do not connect the mains cable to the mains socket until all other connections are complete.

Best Video  
Performance

	Signal Type	Separate audio connection required
 HDMI	HDMI (480i/480p/576i/576p/720p/1080i/1080p*)	No
 VGA	VGA	Yes  PC AUDIO
 Y PB PR	Component Video (480i/480p/576i/576p/720p/1080i/1080p*)	Yes  R L
 SCART	SCART (RGB Input)	No
 S-VIDEO	S-Video	Yes  R L
 VIDEO	Composite Video	 R L

\*1080p: Although this TV is compatible with a 1080p input, the screen is not capable of displaying this resolution and consequently the image will be scaled to suit the screen.

## Connecting an AV Device with HDMI Cable

- This TV can accept High-Definition Multimedia Interface (HDMI) supports HDCP (High-Bandwidth Digital Content Protection) Protocol.
- When you connect to the output of an HD ready player (blu-ray disc player, game console, set-top box or computer) switch to the HDMI function and the TV will automatically detect the resolution used by the HDMI source.
- To get the best picture quality, adjust the blu-ray disc player, game console or set-top box output resolution up to 1920 x 1080p.

- Use a HDMI cable to connect the TV's HDMI input socket to an external AV device's HDMI output socket.
- Plug the connected devices into the mains socket before switching on the **POWER ON/OFF** switch at the side of the TV.
- Press the **⏻ / I** button on the top panel of the TV or the **⏻** button on the remote control to turn on your TV.
- Press the **SOURCE** button to display the Source List. Use the **▲▼** buttons to select **HDMI** and then press the **OK** button or the **▶** button to confirm.



Although this TV is able to connect to HDMI device, it is possible that some devices may not operate correctly.

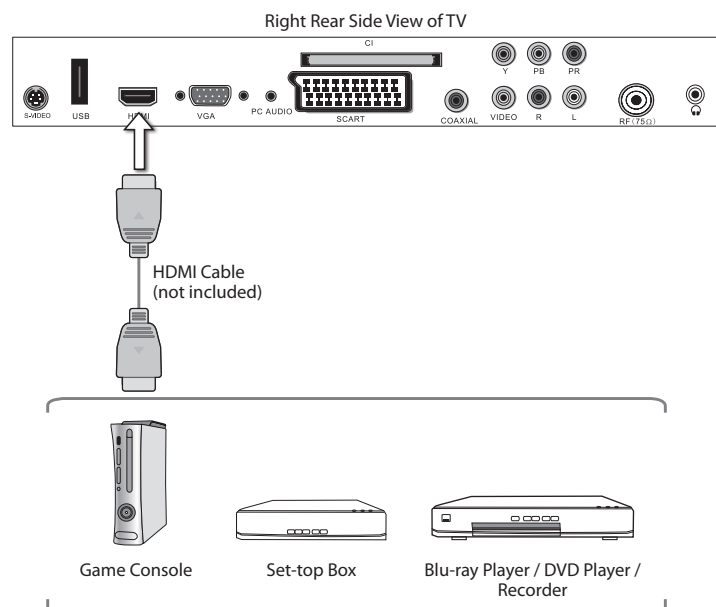

## Connecting a Computer with VGA Cable

1. Use a VGA cable to connect the TV's VGA input socket to a computer's VGA output socket. Use an audio cable to connect the TV's PC AUDIO input socket to the computer's audio output socket.
2. Plug the connected devices into the mains socket before switching on the **POWER ON/OFF** switch at the side of the TV.
3. Press the **⏻/I** button on the top panel of the TV or the **⏻** button on the remote control to turn on your TV.
4. Press the **SOURCE** button to display the Source List. Use the **▲▼** buttons to select **PC** and then press the **OK** button or the **▶** button to confirm.



- The best resolution is 1920\*1080.
- If your computer is set to shut down after a few minutes of idle mode, the TV will also switch to standby due to no signal being received, this is to save energy. Press the **⏻/I** button on the top panel of the TV or the **⏻** button on the remote control to restart the TV.

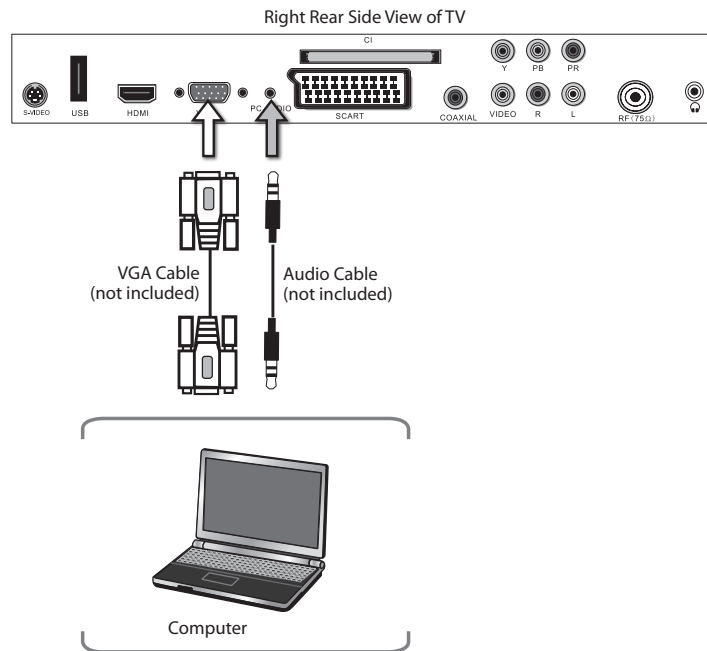

## Connecting an AV Device with Component (YPbPr) Cable

1. Use a component cable to connect the TV's YPbPr input sockets to an external AV device's component output sockets.
2. Use the supplied AV cable to connect the TV's AUDIO(L/R) input sockets to the external AV device's component audio output sockets. (Audio Left = white, and Audio Right = red)

Component port on the TV	Y	Pb	Pr
--------------------------	---	----	----

Video output ports on DVD player	Y	Pb	Pr
	Y	Cb	Cr

3. Plug the connected devices into the mains socket before switching on the **POWER ON/OFF** switch at the side of the TV.
4. Press the **⏻/I** button on the top panel of the TV or the **⏻** button on the remote control to turn on your TV.
5. Press the **SOURCE** button to display the Source List. Use the **▲▼** buttons to select **YPBPR** and then press the **OK** button or the **▶** button to confirm.

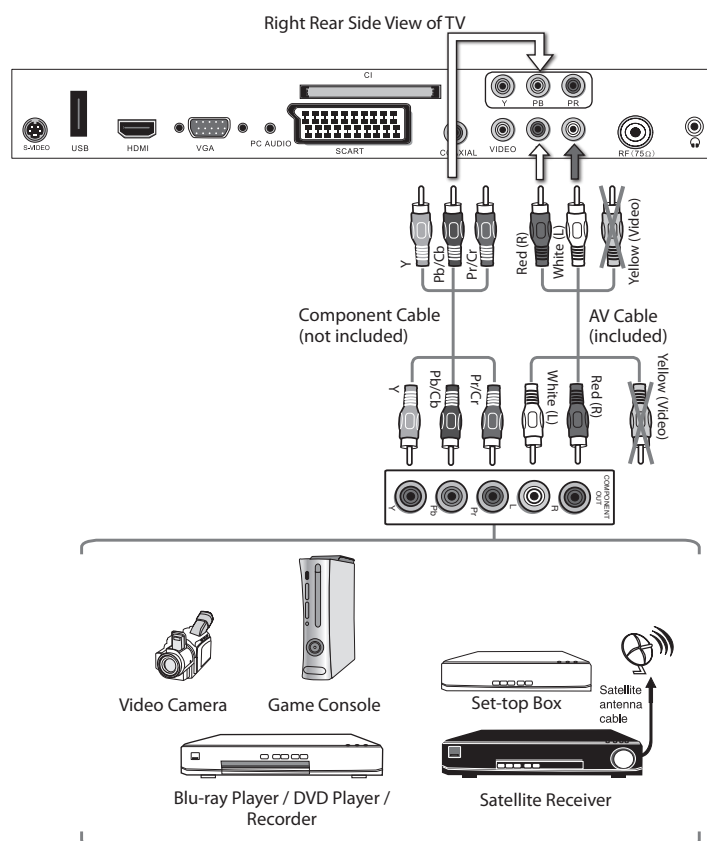

## Connecting an AV Device with SCART Cable

1. Use a SCART cable to connect the TV's SCART input socket to an external AV device's SCART output socket.
2. Plug the connected devices into the mains socket before switching on the **POWER ON/OFF** switch at the side of the TV.
3. Press the **⏻ / I** button on the top panel of the TV or the **⏻** button on the remote control to turn on your TV.
4. The TV will change the input source to **SCART** automatically once the AV device is switched on.

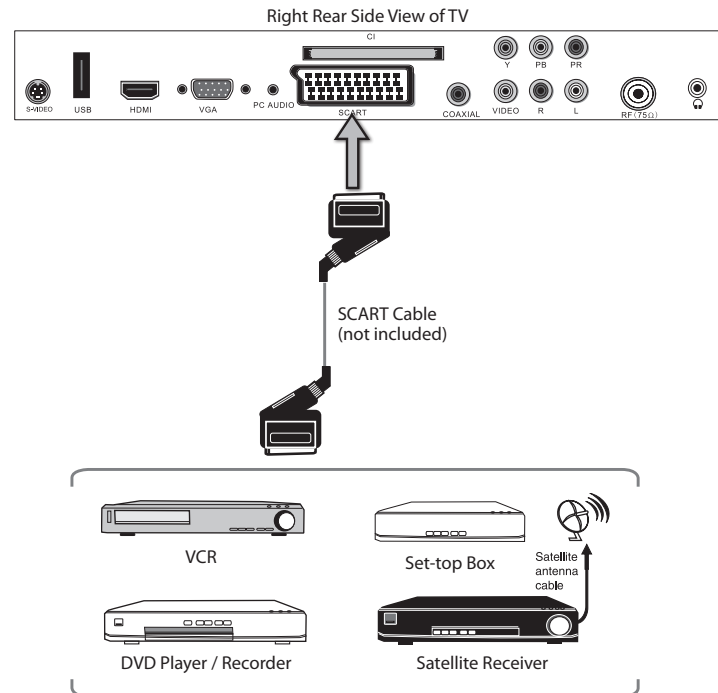

## Connecting an AV Device with S-Video Cable

1. Use a S-Video cable to connect the TV's S-VIDEO input socket to an external AV device's S-VIDEO output socket.
2. Use the supplied AV cable to connect the TV's AUDIO(L/R) input sockets to the external AV device's audio output sockets. (Audio Left = white, and Audio Right = red)
3. Plug the connected devices into the mains socket before switching on the **POWER ON/OFF** switch at the side of the TV.
4. Press the **⏻ / I** button on the top panel of the TV or the **⏻** button on the remote control to turn on your TV.
5. Press the **SOURCE** button to display the Source List. Use the **▲▼** buttons to select **S-VIDEO** and then press the **OK** button or the **▶** button to confirm.

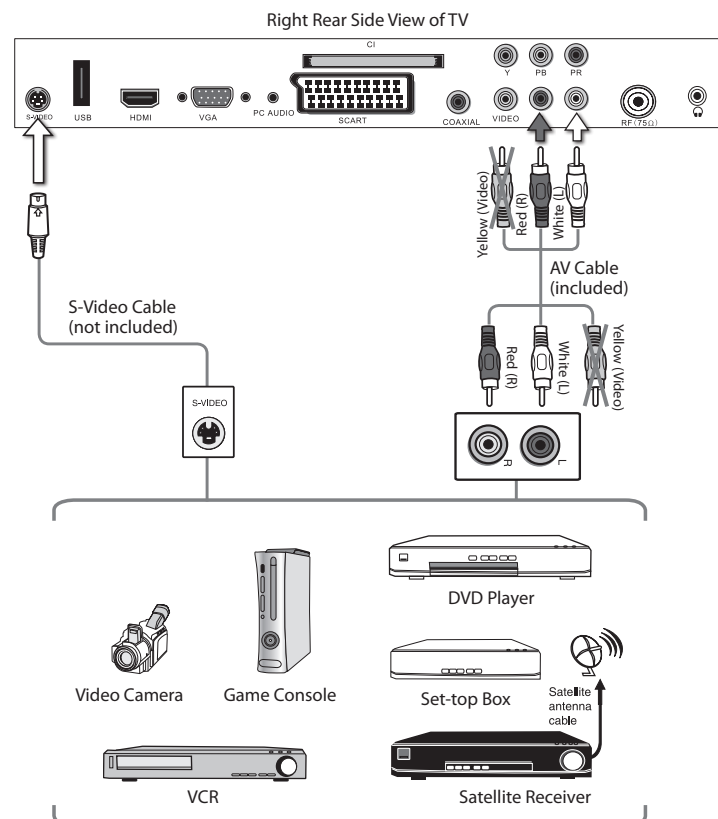

## Connecting an AV Device with Composite Cable

1. Use the supplied AV cable to connect the TV's AUDIO(L/R)/VIDEO input sockets to an external AV device's composite audio/video sockets. (Video = yellow, Audio Left = white, and Audio Right = red)
2. Plug the connected devices into the mains socket before switching on the **POWER ON/OFF** switch at the side of the TV.
3. Press the **⏻** / **I** button on the top panel of the TV or the **⏻** button on the remote control to turn on your TV.
4. Press the **SOURCE** button to display the Source List. Use the **▲▼** buttons to select **AV** and then press the **OK** button or the **▶** button to confirm.

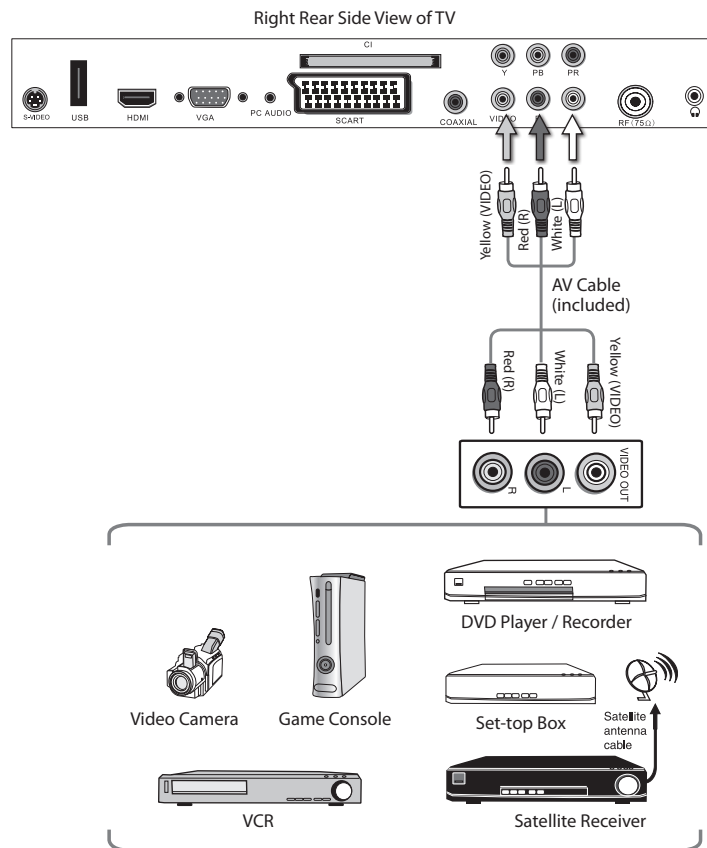

## Connecting a Coaxial Audio Receiver

For better sound quality, you may want to play the DVD audio through your multi-channel audio receiver. (DVD mode)

1. Use an audio cable to connect the TV's COAXIAL output socket to an external audio receiver's audio coaxial input socket.
2. Plug the connected devices into the mains socket before switching on the **POWER ON/OFF** switch at the side of the TV.
3. Press the **⏻** / **I** button on the top panel of the TV or the **⏻** button on the remote control to turn on your TV and your audio receiver and then set it to Coaxial mode.
4. Press the **SOURCE** button to display the Source List. Use the **▲▼** buttons to select **DVD** and then press the **OK** button or the **▶** button to confirm.

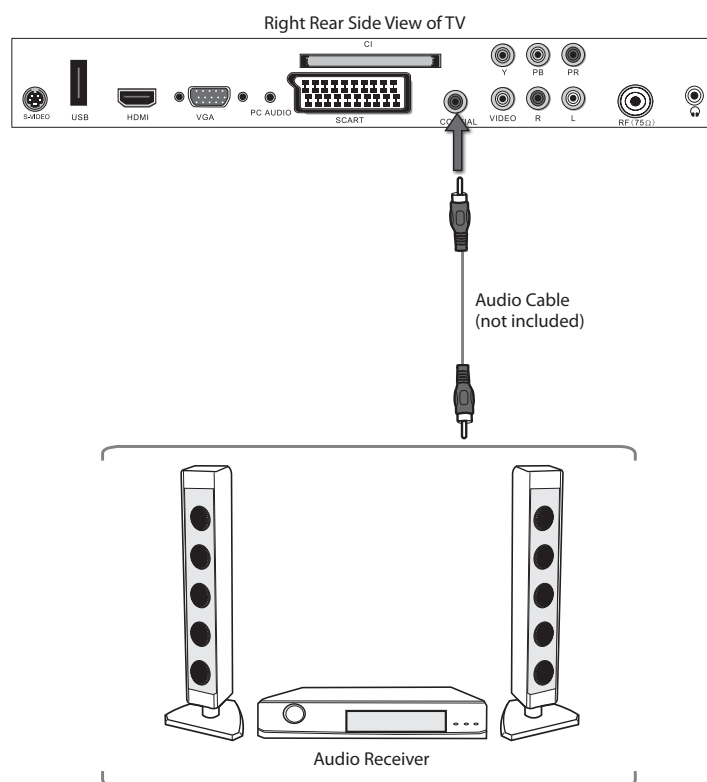

The TV's volume control will have no effect. You may control the audio level via the Audio Receiver.

## Connecting Earphones

Connect your earphones to the TV's  socket.

Before putting on earphones, turn the volume down then put the earphones on and slowly increase the volume until you reach a comfortable listening level.



Listening to loud sounds for prolonged periods of time may permanently damage your hearing.

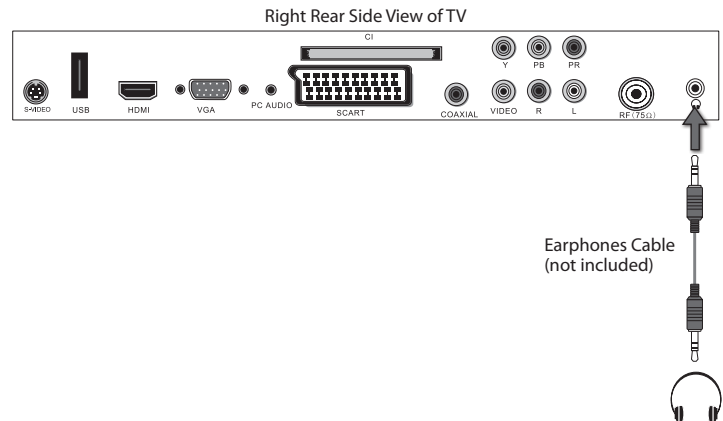

## Connecting a USB Storage Device

1. Switch off the TV before connecting any USB storage device.
2. Connect your USB storage device to the USB port of your TV.
3. Plug the connected devices into the mains socket before switching on the **POWER ON/OFF** switch at the side of the TV.
4. Press the  / **I** button on the top panel of the TV or the  button on the remote control to turn on your TV and your audio receiver and then set it to Coaxial mode.
5. Press the **SOURCE** button to display the Source List. Use the   buttons to select **DTV** and then press the **OK** button or the  button to confirm. Press the **MEDIA** button to enter Media Mode. (Refer to page 35-42 for details.)



- If a hard disk is used, make sure its mains adapter is connected to the mains supply.
- If a USB hub is used, make sure its mains adapter is connected to the mains supply as the total current consumption may exceed 500mA.
- If a USB hub is used, you may refer to the **Recording Device** on page 38 for details on selecting the active device when several USB storage devices are connected.
- The maximum supported storage space of the hard disk is 1 TB.
- The file system only supports FAT32 format.
- If you want to store the video streaming of a DTV programme, the transfer rate of the USB storage device must not be less than 5MB/s, otherwise the picture and sound of the programme will be affected and a warning statement will be shown on the screen. If this happens, please upgrade your USB storage device.
- The TV screen will be blank temporarily as it will take time to start up and stabilise the connected hard disk. This is normal and the starting time may vary depending on the brand and the memory size of the connected hard disk.
- Disconnect the USB storage device if it is not in use.

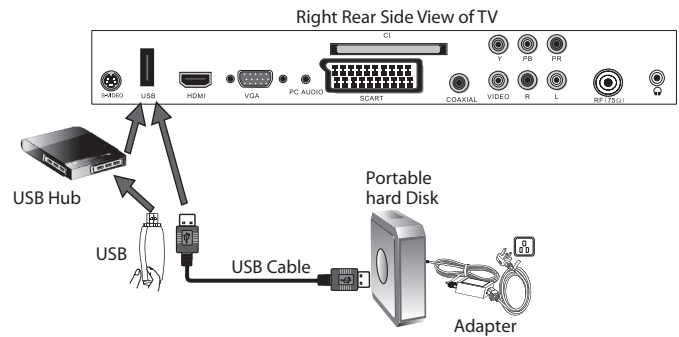



## Connecting the Aerial

Connect one end of the RF coaxial cable to the aerial socket on the wall and the other end of the cable to the RF (75Ω) socket on the right rear side of your TV.

 Do not connect the TV to the mains supply until you have completed all the connections.

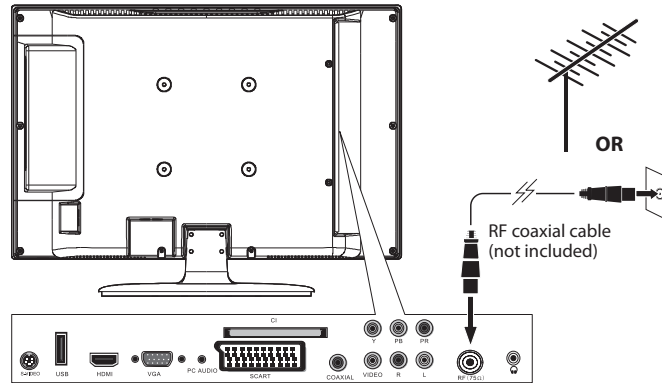

## Turning the TV On for the First Time

1. Connect the mains cable to the mains socket after you have completed all the connections.
2. Switch on the **POWER ON/OFF** switch at the side of the TV. At this stage, the TV switches to standby mode. The red LED indicator will illuminate on the front panel of the TV.
3. In standby mode, press the **⏻ / I** button on the top panel of the TV or the **⏻** button on the remote control to turn the TV on. The red LED indicator will turn blue.

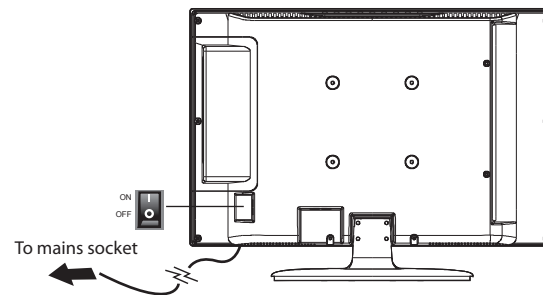

 Always disconnect the TV from the mains socket when not in use for a long period of time. The **⏻ / I** button on the top panel of the TV or the **⏻** button on the remote control is only used for switching the TV into standby, it does not disconnect the TV from the mains power. To completely disconnect the mains power, please remove the mains plug from the mains socket or switch off the **POWER ON/OFF** switch.

4. The first time you turn the TV on, it will go straight into the **FIRST TIME INSTALLATION** menu. (If you have already installed the TV using the Quick Start Guide, please go to the next step "Selecting the Input Source" on the next page.)
5. Press the **▲◀▶▼** buttons to navigate the menu and change the settings.

<b>Country</b>	Select the country where you will operate the TV.
<b>Delete Program</b>	Select to delete the tuned channels in the TV.
<b>Search Program</b>	Select to search automatically for analogue and digital TV programmes.

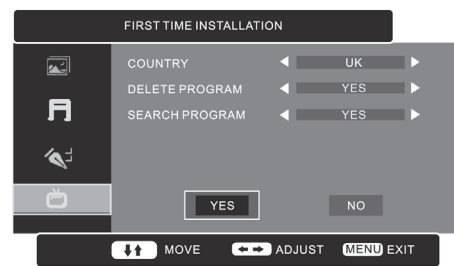

6. Select **YES** on the screen and then press the **OK** button on the remote control to start the First Time Installation. Select **NO** on the screen to cancel the First Time Installation. A First Time Installation reminder will appear the next time you turn on the TV.



## Selecting the Input Source

1. Press the **SOURCE** button to display the input source list.
2. Press the **▲▼** buttons to select the input source that you want: DTV / TV / DVD / AV / S-VIDEO / SCART / YPBPR / HDMI / PC.
3. Press the **OK** button to confirm your selection.

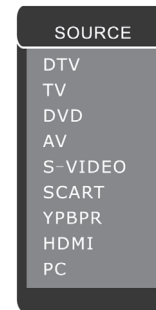

## Channel Selection

- Press the **CH + / -** buttons repeatedly or the **0-9** buttons to select the channel.



### Alternative

In DTV mode, press the **OK** button to enter the **Channel List**. Then use the **▲▼** buttons to highlight and select the channel. Press the **OK** button to view the selected channel.

If a blocked channel is selected, the password screen will be displayed. Press the **0-9** buttons to enter the password, the channel will then be unlocked (refer to page 27 and 29 for details on **Channel Edit**).

- Press the **FAV + / -** buttons repeatedly to select the favourite channel if you have previously preset your favourite channels.



### Alternative

Press the **FAV** button to view the **Favourite List**. Then use the **▲▼** buttons to highlight and select the channel. Press the **OK** button to view the selected channel.

- Press the **↺** button to return to the previously viewed channel.

## Volume Adjustment

- Press the **VOL + / -** buttons to adjust the volume.
- If you wish to switch the sound off, press the **⊗** button, press the **⊗** button again or the **VOL+** button to resume audio listening.

# Customising the PICTURE Setting

## Picture Mode

Allows you to set your preferred picture mode.

1. Press the **MENU** button and then use the **▲▼** buttons to select the **PICTURE** menu and then press the **►** button.
2. Press the **▲▼** buttons to highlight an individual Picture option.
3. Press the **◀▶** buttons to change the following settings.

<b>Picture Mode</b>	Cycles among display types: Personal / Standard / Movie / Mild / Game.  <b>Alternative</b> Press the <b>P.MODE</b> button to select the display type directly.
<b>Brightness</b>	Increase or decrease the amount of white in the picture. (for Personal mode)
<b>Contrast</b>	Adjusts the difference between light and dark levels in the picture. (for Personal mode)
<b>Colour</b>	Controls the colour intensity. (for Personal mode)
<b>Tint</b> (For NTSC format)	Adjusts the balance between red and green levels. (Tint is only available for NTSC signal reception.)

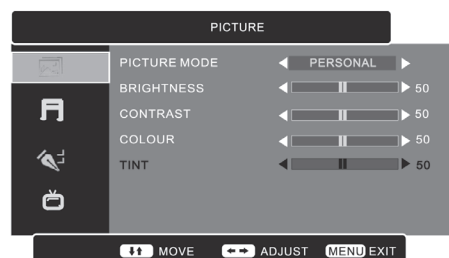

4. Press the **MENU** button to save the settings and return back to the previous menu.
5. Press the **EXIT** button to exit the menu.

## Customising the SOUND Setting

### Sound Mode

Allows you to select an audio-enhancement technique.

1. Press the **MENU** button and then use the **▲▼** buttons to select the **SOUND** menu and then press the **►** button.
2. Press the **▲▼** buttons to highlight an individual Sound option.
3. Press the **◀▶** buttons to change the following settings.

<b>Sound Mode</b>	Allows selection of an audio-enhancement technique from among the following options: Standard / Music / Voice / Theatre / Personal.   <b>Alternative</b> Press the <b>S.MODE</b> button to select the audio-enhancement technique.
<b>Bass</b>	Controls the relative intensity of lower-pitched sounds.
<b>Treble</b>	Controls the relative intensity of higher pitched sounds.
<b>Balance</b>	Adjusts the relative volume of the speakers in a stereo speaker system.
<b>Auto Volume Control (AVC)</b>	Volume levels are automatically controlled. (e.g. advertisements tend to be louder than the programmes)

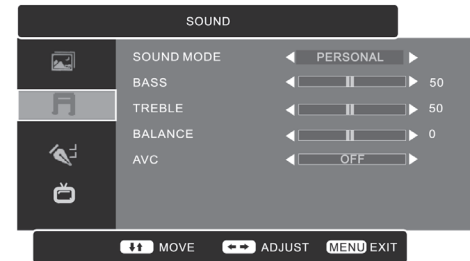

4. Press the **MENU** button to save the settings and return back to the previous menu.
5. Press the **EXIT** button to exit the menu.

### Stereo / Dual Sound Reception (TV Mode)

When a programme is selected, press the **NICAM** button to display the sound information for the selected station.

Broadcast	On Screen Display
Mono	MONO
Stereo	STEREO
Dual	DUAL I, DUAL II, DUAL I/II

#### Mono sound selection

If the stereo signal is weak in stereo reception, you can switch to mono by pressing the **NICAM** button. In mono reception, the clarity of sound is improved. To switch back to stereo, press the **NICAM** button again.

#### Language selection for dual language broadcast

If a programme can be received in two languages (dual language), you can switch to **DUAL I**, **DUAL II**, **DUAL I/II** or **MONO** by pressing the **NICAM** button repeatedly.

DUAL I	Sends the primary broadcast language to the loudspeakers
DUAL II	Sends the secondary broadcast language to the loudspeakers
DUAL I/II	Sends the primary and secondary broadcast languages to the loudspeakers

### Speaker Sound Output Selection (DTV Mode)

Press the **NICAM** button to switch between different audio languages (only applicable when the TV programme has this feature).

# Customising the FUNCTION Setting

## Video Size

Allows you to watch the screen in various picture formats. For TV Mode, Auto / Full / 4:3 / 14:9 / Zoom are the available options. For DTV mode, Auto / Full are the available options. For YPbPr and HDMI mode, Full / 4:3 are the available options.

1. Press the **MENU** button and then use the **▲▼** buttons to select the **FUNCTION** menu and then press the **▶** button.
2. Press the **▲▼** buttons to select **VIDEO SIZE**.
3. Press the **◀▶** buttons to select the desired format.

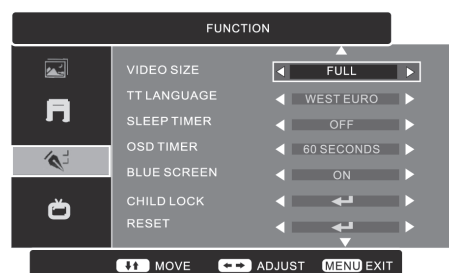

### Auto

When your TV receives a 4:3 or 16:9 signal it will automatically change to the picture format broadcast.

4:3



16:9



### 14:9

You can view a picture format of 14:9 or a general TV programme in the 14:9 mode. The 14:9 screen is viewed in the same way as in 4:3, but is magnified to the left and right.



### Full

This selection will allow you to view the picture in full screen.



### 4:3

This selection will allow you to view a picture with an original 4:3 aspect ratio, black bars will appear on both the left and right of the screen.



### Zoom

This selection will allow you to view the picture without any alteration, while filling the entire screen. However, the top and bottom of the picture will be cropped.

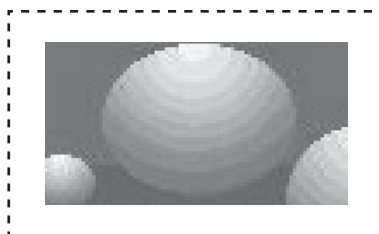

4. Press the **MENU** button to save the setting and return back to the previous menu.
5. Press the **EXIT** button to exit the menu.

## TT Language

Allows you to select your preferred Teletext language.

1. Press the **MENU** button and then use the **▲▼** buttons to select the **FUNCTION** menu and then press the **▶** button.
2. Press the **▲▼** buttons to select **TT Language**.
3. Press the **◀▶** buttons to change the settings.
4. Press the **MENU** button to save the setting and return back to the previous menu.
5. Press the **EXIT** button to exit the menu.

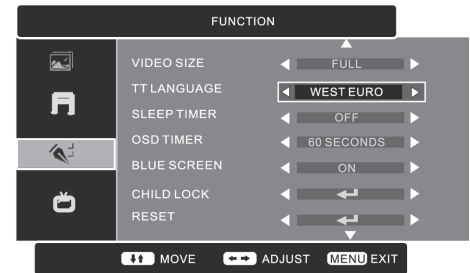

## Sleep Timer

The sleep timer automatically switches the TV to standby after the preset time has elapsed.



The clock will be set automatically when receiving a digital signal.  
Time must be set before using Sleep Timer / OSD Timer function.

1. Press the **MENU** button and then use the **▲▼** buttons to select the **FUNCTION** menu and then press the **▶** button.
2. Press the **▲▼** buttons to select **SLEEP TIMER**.
3. Press the **◀▶** buttons to select a period of time after which the TV automatically switches to standby mode: 15 / 30 / 45 / 60 / 75 / 90 / 105 / 120 min / OFF. The timer begins to count down from the number of minutes selected.
4. Press the **MENU** button to save the setting and return back to the previous menu.
5. Press the **EXIT** button to exit the menu.

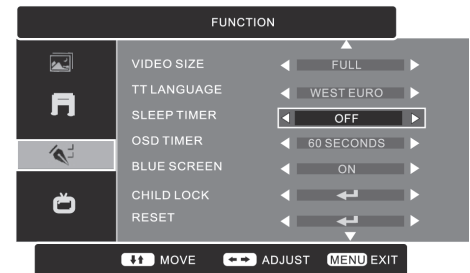

### Alternative

1. You may press the **SLEEP** button repeatedly to select the number of minutes: 15 / 30 / 45 / 60 / 75 / 90 / 105 / 120 min / OFF directly.
2. To cancel the sleep time, press the **SLEEP** button repeatedly until Off appears.



If you turn the TV off after setting the sleep timer, the sleep timer setting will be erased.

## OSD Timer

Allows you to select the display time of the on-screen menu.

1. Press the **MENU** button and then use the **▲▼** buttons to select the **FUNCTION** menu and then press the **▶** button.
2. Press the **▲▼** buttons to select **OSD TIMER**.
3. Press the **◀▶** buttons to select time: 5 / 10 / 30 / 60 sec / NEVER.
4. Press the **MENU** button to save the setting and return back to the previous menu.
5. Press the **EXIT** button to exit the menu.

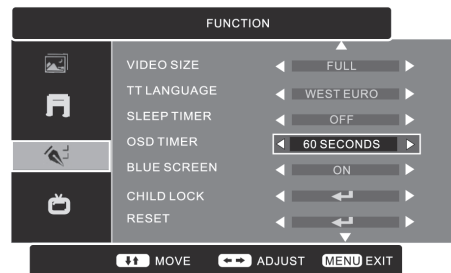

## Blue Screen

Allows the blue background to turn On or Off during weak or no signal conditions.

1. Press the **MENU** button and then use the **▲▼** buttons to select the **FUNCTION** menu and then press the **▶** button.
2. Press the **▲▼** buttons to select **BLUE SCREEN**.
3. Press the **◀▶** buttons to turn it ON or OFF.
4. Press the **MENU** button to save the setting and return back to the previous menu.
5. Press the **EXIT** button to exit the menu.

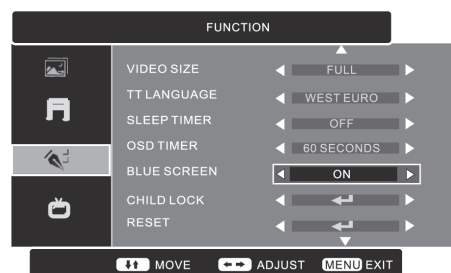

## Child Lock

Child Lock is designed to prevent accidental retuning of the TV / losing channels and prevent children watching unsuitable programmes.

The Lock System must be set to On for this function to operate. If the Child Lock is set to On, a valid password must be entered when you access the Auto Tuning / Manual Tuning / Program Edit / First Time Installation.

1. Press the **MENU** button and then use the **▲▼** buttons to select the **FUNCTION** menu and then press the **▶** button.
2. Press the **▲▼** buttons to select **CHILD LOCK** and then press the **OK** button or the **▶** button.
3. Press the **▲▼** buttons to select **CHILD LOCK** and then press the **◀▶** buttons to select **On**.

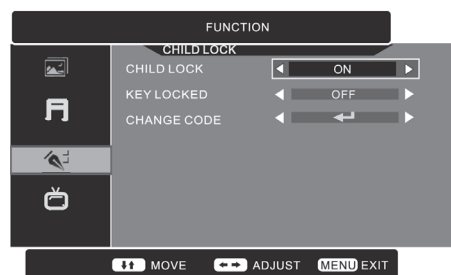
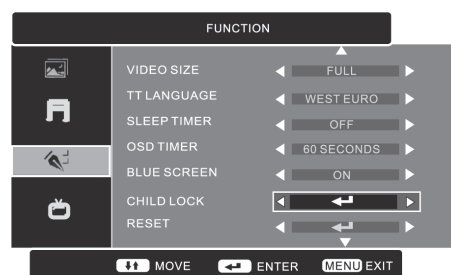

4. Press the ▼ button and then press the ► button to select **CHANGE CODE**.
5. Use the **0-9** buttons to input a 4-digit password.



The default password is "0000".  
If you change the password, be sure to remember the new password!  
If you forget your password, press the master password "8899" on the remote control.

6. Re-enter new password for confirmation.
7. Press the **MENU** button to save the setting and return back to the previous menu.
8. Press the **EXIT** button to exit the menu.



## Key Locked

Key Locked is designed to prevent children from pressing the buttons on the TV. The Lock System must be set to On for this function to operate. If the Key Locked is set to On, all buttons on the TV will be locked. All TV operations can be controlled by the remote control only.

1. Press the **MENU** button and then use the ▲▼ buttons to select the **FUNCTION** menu and then press the ► button.
2. Press the ▲▼ buttons to select **CHILD LOCK** and then press the **OK** button or the ► button.
3. Press the ▲▼ buttons to select **KEY LOCKED** and then press the ◀▶ buttons to select **ON**.

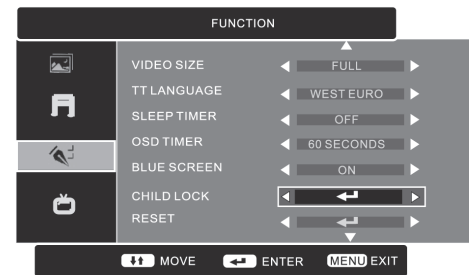

4. Press the **MENU** button to save the setting and return back to the previous menu.
5. Press the **EXIT** button to exit the menu.



To switch off the Key Locked, repeat steps 1-3 and then press the ◀▶ buttons to select **OFF**.

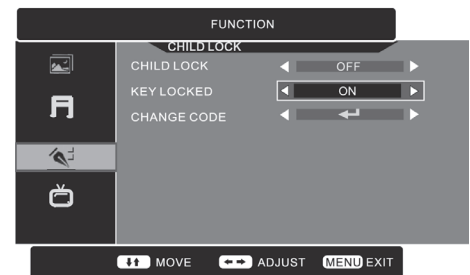



## Reset

Restores all settings to factory defaults.

1. Press the **MENU** button and then use the **▲▼** buttons to select the **FUNCTION** menu and then press the **▶** button.
2. Press the **▲▼** buttons to select **RESET** and then press the **OK** button or the **▶** button.
3. Press the **◀▶** buttons to select **YES** on the screen. All settings will be reset to factory defaults and the **FUNCTION** menu will disappear.

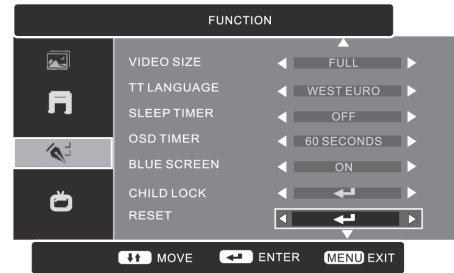

## Installation

Allows you to set up your TV if you have not previously done so or if you have moved house.

1. Press the **MENU** button and then use the **▲▼** buttons to select the **FUNCTION** menu and then press the **▶** button.
2. Press the **▲▼** buttons to select **INSTALLATION** and then press the **OK** button or the **▶** button.

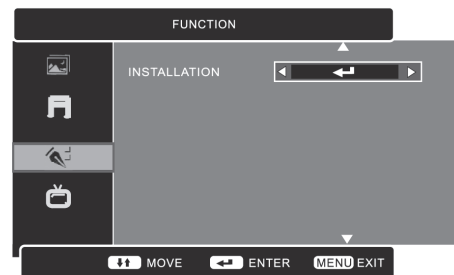

3. Press the **▲◀▶▼** buttons to navigate the menu and change the settings.

<b>Country</b>	Select the country where you will operate the TV.
<b>Delete Program</b>	Select to delete the tuned channels in the TV.
<b>Search Program</b>	Select to search automatically for analogue and digital TV programmes.

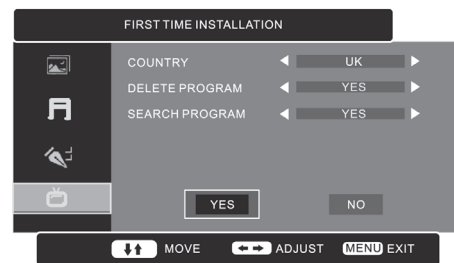

4. Select **YES** on the screen and then press the **OK** button on the remote control to start the First Time Installation. Select **NO** on the screen to cancel the First Time Installation. A First Time Installation reminder will appear the next time you turn on the TV.

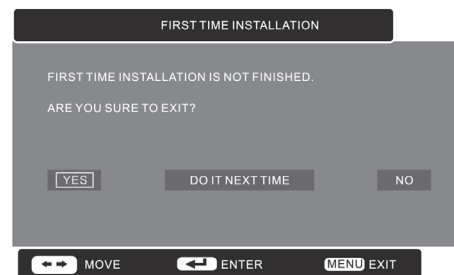

If you stop the tuning before it has finished, the TV will report it as a no signal error. This is normal because all previous channel memory has been cleared before tuning is carried out.

## Customising the TV Setting (TV Mode)

### Country

Allows you to select the country where you are using the TV.

1. Press the **MENU** button and then use the **▲▼** buttons to select the **TV** menu and then press the **▶** button.
2. Press the **▲▼** buttons to select **COUNTRY**.
3. Press the **◀▶** buttons to select the country: UK, Italy, Spain, France, Germany and Other.
4. You may now proceed to the Auto Tuning or Manual Tuning.

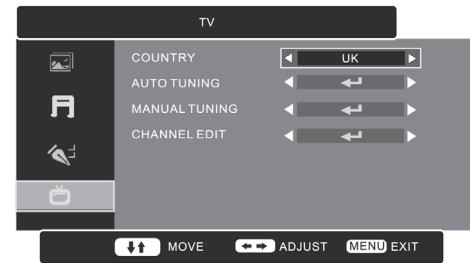

### Auto Tuning

Use this to automatically find and store all available channels. This is normally recommended if some channels have been added/removed by the broadcaster or you have moved house.

1. In the **TV** menu, press the **▲▼** buttons to select **AUTO TUNING** and then press the **OK** button or the **▶** button.

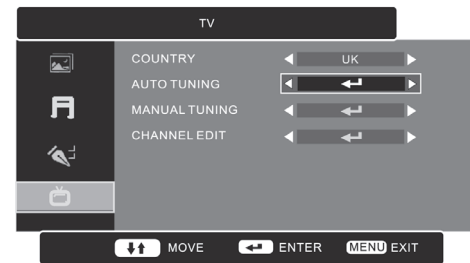

2. The Auto Tuning screen will pop up. Press the **◀▶** buttons to select **YES** and then press the **OK** button to start the auto tuning.



If you stop the tuning before it has finished, the TV will report it as a no signal error. This is normal because all previous channel memory has been cleared before tuning is carried out.

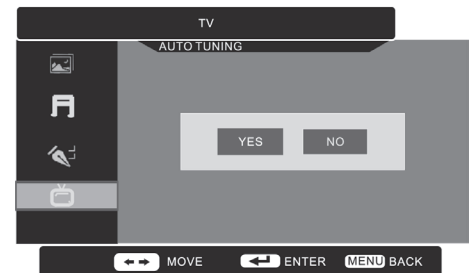

## Manual Tuning

Allows you to make manual fine tuning adjustments if the channel reception is poor under TV mode.

1. In the **TV** menu, press the **▲▼** buttons to select **MANUAL TUNING** and then press the **OK** button or the **▶** button.

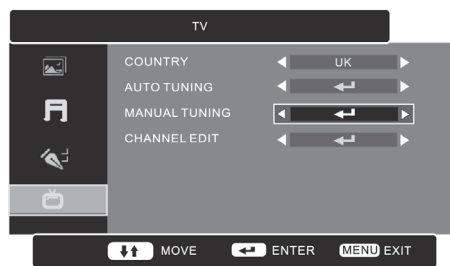

2. Press the **▲◀▶▼** buttons to change the following settings.

<b>Channel</b>	To select a channel number for a particular frequency through manual tuning.
<b>Sound System</b>	To select TV sound system between: BG / I / DK / L. (for AUTO & SECAM system only)
<b>Colour System</b>	To select TV colour system between: AUTO / PAL / SECAM. (not available for I sound system)
<b>Auto Fine Tune (AFT)</b>	To fine tune the channel automatically when the signal is weak.
<b>Manual Tuning</b>	Performs manual search for analogue TV programmes. Press and hold the <b>◀▶</b> buttons to adjust the channel frequency. Press the <b>◀▶</b> buttons repeatedly to perform fine tuning.

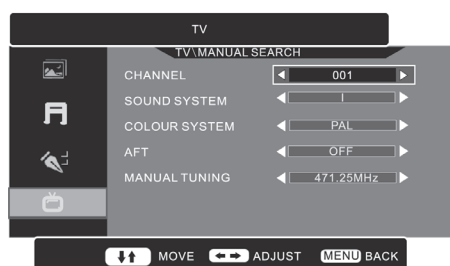

3. Press the **MENU** button to save the setting and return back to the previous menu.
4. Press the **EXIT** button to exit the menu.

## Channel Edit

Allows you to edit analogue TV programmes in the Channel List.

1. Press the **MENU** button and then use the **▲▼** buttons to select the **TV** menu and then press the **▶** button.
2. Press the **▲▼** buttons to select **CHANNEL EDIT** and then press the **OK** button or the **▶** button.

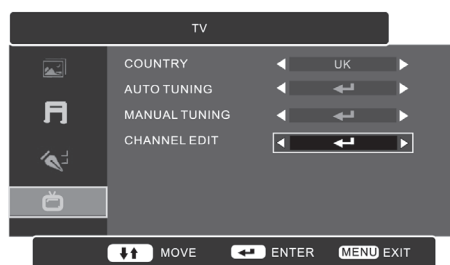

3. **To add a channel to the favourite channel list**
  - a. Press the **▲▼** buttons to highlight a channel and then press the **GREEN** button.
  - b. Press the **GREEN** button again to undo it.

### To Skip

- a. Press the **▲▼** buttons to highlight a channel and then press the **YELLOW** button.
- b. Press the **YELLOW** button again to undo it.

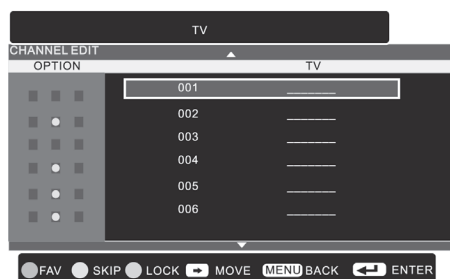

**To Lock**

- a. Press the ▲▼ buttons to highlight a channel and then press the **BLUE** button.
- b. Press the **BLUE** button again to unlock.

**To Move**

- a. Press the ▲▼ buttons and then press the ► button to select a channel.
- b. Press the ▲▼ buttons to move the selected channel.
- c. Press the **OK** button to confirm.

**To Rename**

- a. Press the ▲▼ buttons to highlight a channel and then press the **OK** button.
  - b. Key in the character by press the **OK** button on the remote control.
  - c. Press the ▲▼ buttons and then press the ► button to select **OK** displayed on the screen when finished.
4. Press the **MENU** button to save and return back to the previous menu.
  5. Press the **EXIT** button to exit the menu.

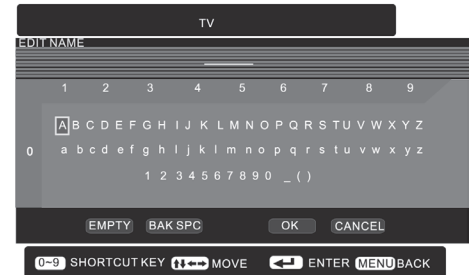

## Customising the TV Settings (DTV Mode)

### Auto Tuning

Use this to automatically find and store all available channels. This is normally recommended if some channels have been added/removed by the broadcaster or you have moved house.

1. Press the **MENU** button and then use the ▲▼ buttons to select the **DTV** menu and then press the ► button.
2. Press the ▲▼ buttons to select **AUTO TUNING** and then press the **OK** button or the ► button.

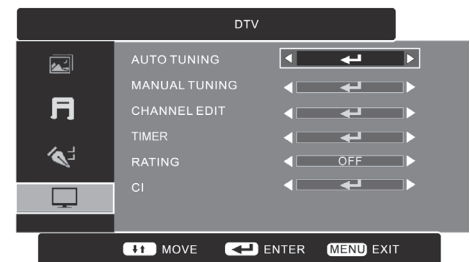

3. The Auto Tuning screen will pop up. Press the ◀▶ buttons to select **YES** and then press the **OK** button to start the auto tuning.



If you stop the tuning before it has finished, the TV will report it as a no signal error. This is normal because all previous channel memory has been cleared before tuning is carried out.

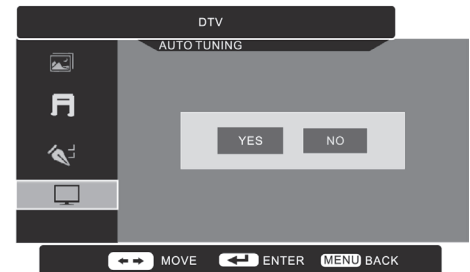

## Manual Tuning

Allows you to make manual fine tuning adjustments if the channel reception is poor under DTV mode.

1. Press the **MENU** button and then use the **▲▼** buttons to select the **DTV** menu and then press the **▶** button.
2. Press the **▲▼** buttons to select **MANUAL TUNING** and then press the **OK** button or the **▶** button.

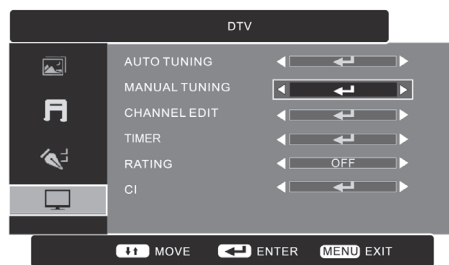

3. Press the **◀▶** buttons to change the following settings.

<b>Channel</b>	To select a channel number for a particular frequency through manual tuning.
<b>Start Search</b>	Performs manual search for digital TV programmes.

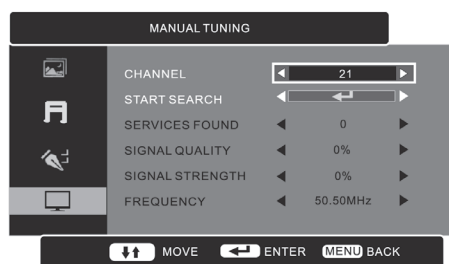

4. Press the **MENU** button to save the setting and return back to the previous menu.
5. Press the **EXIT** button to exit the menu.

## Channel Edit

Allows you to edit DTV programmes in the Channel List.

1. Press the **MENU** button and then use the **▲▼** buttons to select the **DTV** menu and then press the **▶** button.
2. Press the **▲▼** buttons to select **CHANNEL EDIT** and then press the **OK** button or the **▶** button.

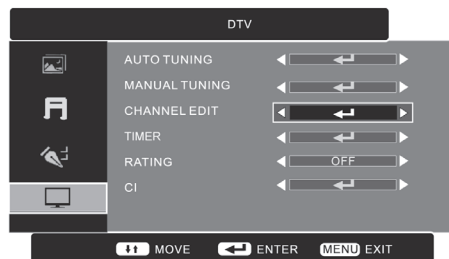

3. **To Lock**
  - a. Press the **BLUE** button on the remote control.
  - b. Press the **▲▼** buttons to highlight a channel.
  - c. Press the **OK** button to lock the channel.
  - d. Press the **OK** button again to unlock.
- To Delete**
  - a. Press the **▲▼** buttons to highlight a channel.
  - b. Press the **RED** button to delete the channel.
- To Reorder**
  - a. Press the **▲▼** buttons to highlight a channel.
  - b. Press the **GREEN** button and then press the **▲▼** buttons to move the channel.
  - c. Press the **OK** button to confirm.

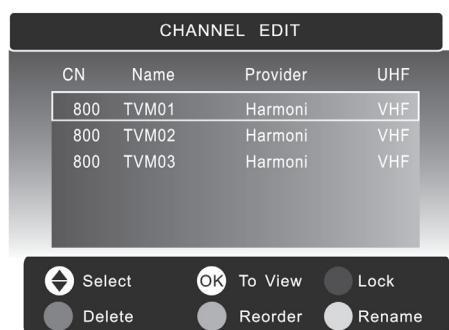

- To Rename**
  - a. Press the **▲▼** buttons to highlight a channel and then press the **YELLOW** button.
  - b. Key in the character and then press the **OK** button.
  - c. Press the **GREEN** button when finished.
  - d. Press the **YELLOW** button to cancel.
4. Press the **MENU** button to save and return back to the previous menu.
5. Press the **EXIT** button to exit the menu.

## Timer

Timer programming is only available when a USB storage device is connected.

1. Press the **MENU** button and then use the **▲▼** buttons to select the **DTV** menu and then press the **▶** button.
2. Press the **▲▼** buttons to select **TIMER** and then press the **OK** button or the **▶** button.
3. See page 42 for details on **Timer Programming**.

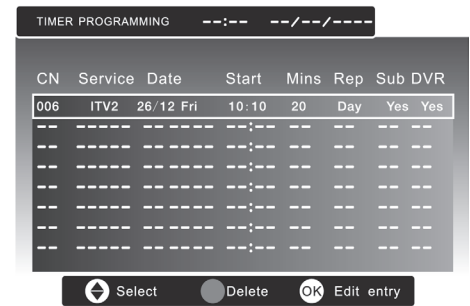
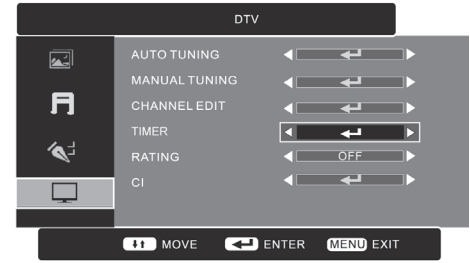

## Rating

This function allows you to set up blocking schemes to block specific channels and ratings. It operates according to information from the broadcasting station, therefore if the signal has incorrect information, this function does not operate.

This TV is programmed to remember which option it was last set to even if you switch the TV off.

When a programme is locked or rated with delayed state, the message "locked programme" is displayed without displaying the password window.

When recording a locked or rated programme, the recorded programme will be locked unless you enter the password before the recording is finished. If you wish to play the locked programme, you should enter the password.

1. Press the **MENU** button and then use the **▲▼** buttons to select the **DTV** menu and then press the **▶** button.
2. Press the **▲▼** buttons to select **RATING**.
3. Press the **◀▶** buttons to select a different rating.
4. Press the **MENU** button to save the setting and return back to the previous menu.
5. Press the **EXIT** button to exit the menu.

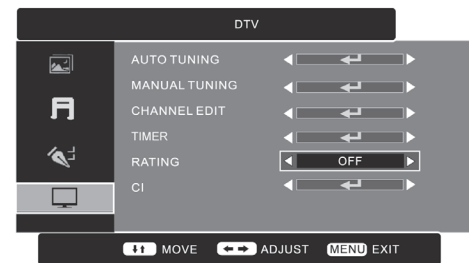

## CI (Common Interface) (DTV Mode)

The common interface allows the use of a Common Access Module to enable you to view scrambled (pay to view) services. These services are provided by TopUp TV (UK only) and others. The Common Access Module and viewing card can be obtained from the service provider.



Do not repeatedly insert or remove the Common Access Module as this may damage the interface and cause a malfunction.

This feature is not available in all countries.

### To insert the Common Access Module

1. Before you insert the Common Access Module, ensure that the TV is switched off and the viewing card is inserted **in accordance with the Service Provider's instructions**.
2. Insert the Common Access Module into the slot. Flip the Common Access Module to another side and try again if you feel resistance.
3. Switch the TV on.

### To remove the Common Access Module

1. Before you remove the Common Access Module, ensure that the TV is switched off.
2. Pull the Common Access Module from the slot.
3. Switch the TV on.

### To view the module information

1. Press the **MENU** button and then use the **▲▼** buttons to select the **DTV** menu and then press the **▶** button.
2. Press the **▲▼** buttons to select **CI**.
3. Press the **OK** button or the **▶** button to display the Common Interface screen and then press the **OK** button.
4. Press the **▲▼** buttons and then press the **OK** button to display CI information (Status / Messages / Language Setup / Update Software / Quit).
5. Press the **EXIT** button to return back to the previous menu.
6. Press the **EXIT** button again to exit the menu.

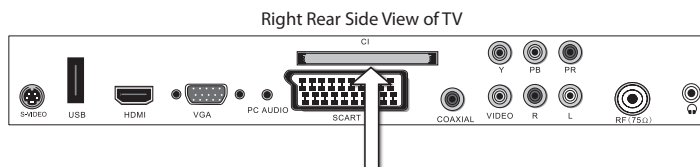

### CI (Common Interface) slot

Allows the Common Access Module to be inserted and access the content that has been encrypted.

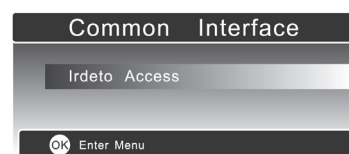
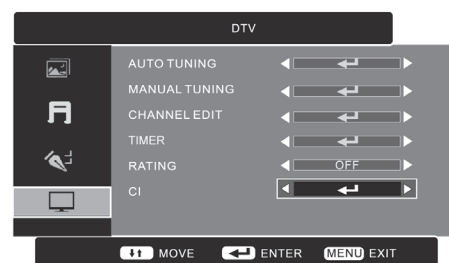
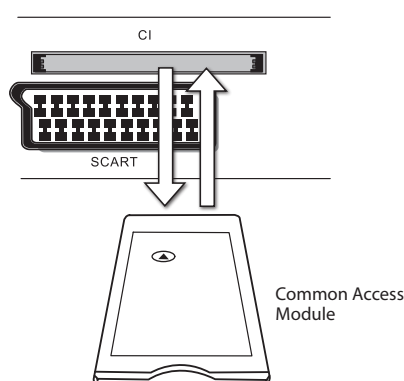

This screen is for illustration only.

## Customising the TV Settings (PC Mode)

Allows you to adjust the PC desktop content.

1. Press the **MENU** button and then use the **▲▼** buttons to select the **PC** menu and then press the **▶** button.
2. Press the **▲▼** buttons to highlight an individual PC Position option.
3. Press the **◀▶** buttons to change the following settings.

<b>H Position</b>	Adjusts the position of the picture left and right in the window.
<b>V Position</b>	Adjusts the position of the picture up and down in the window.
<b>Phase</b>	Controls the signal phase, which can improve focus clarity and image stability based on the PC mode.
<b>Clock</b>	Control the signal clock, which can improve the image stability based on the PC mode.
<b>Auto Adjust</b>	Allows you to synchronise PC signal automatically.

4. Press the **MENU** button to save the settings and return back to the previous menu.
5. Press the **EXIT** button to exit the menu.

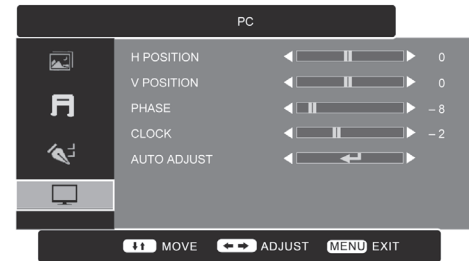

## Customising the TV Settings (HDMI and YPbPr Modes)

Allows you to adjust the displayed content.

1. Press the **MENU** button and then use the **▲▼** buttons to select the **HDMI / YPBPR** menu and then press the **▶** button.
2. Press the **▲▼** buttons to highlight an individual HDMI / YPBPR option.
3. Press the **◀▶** buttons to change the following settings.

<b>H Position</b>	Adjusts the position of the picture left and right in the window.
<b>V Position</b>	Adjusts the position of the picture up and down in the window.
<b>Position Reset</b>	Resets to default settings.

4. Press the **MENU** button to save the setting and return back to the previous menu.
5. Press the **EXIT** button to exit the menu.

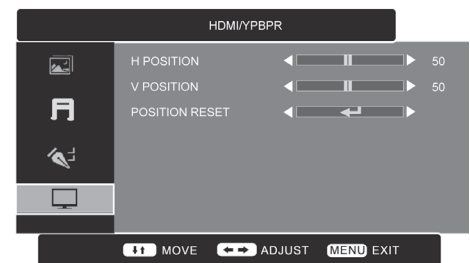



## Teletext (TV Mode)

Teletext is a free service broadcast by some TV stations which gives up-to-the-minute information on news, weather, television programmes, share prices and many other topics. Using the Teletext control buttons you can view pages of information that are listed in the teletext index.

### To Turn on Teletext Function



Make sure the TV channel you are watching transmits teletext.  
“No Teletext” sign will show on the screen if teletext is not available.

In TV mode, press the **TEXT** button to enter Teletext mode. Press the **INDEX** button to display the index page.

Press the **TEXT** button twice to exit and the TV will return to the channel you were watching.

### To select a page of text

Find the number of the page in the index and enter it using the **0-9** buttons. The page number will appear on the top left corner of the screen.

The page counter will search for your page. When it finds it, the page will be displayed.

To move to the next page of text, press the **▲** button.

To move to the previous page, press the **▼** button.

To return to the index page, enter the “**100**” by using the **0-9** buttons or press the **INDEX** button.

### Mix

To view a page of text whilst watching a TV programme, press the **TEXT** button twice. The text will be superimposed over the TV programme.

### Page search while watching TV

Press the **CANCEL** button while viewing teletext, enter the page number you want by using the **0-9** buttons. The page number will remain on the top left hand corner of the screen.

### Double height text

If you have difficulty reading the text on the TV you can double the height of the text.

Press the **SIZE** button. The top half of the page will be displayed in double height text.

Press the **SIZE** button again. The bottom half of the page will be displayed in double height text.

Press the **SIZE** button again to return to the full page.

### Page HOLD

If the page of text you have selected contains subpages, these subpages will automatically be displayed in order with a delay to allow you to have enough time to read the page.

Press the **◀▶** buttons to scroll through the subpages.



#### Alternative

Press the **SUBPAGE** button, then enter a 4-digit page number.

### To Reveal Information

Press the **REVEAL** button to reveal concealed information (quiz answers etc.).

Press the **REVEAL** button again to conceal the information again.

### Fasttext

At the bottom of the teletext screen is a row of subject headings in red, green, yellow and blue.

The remote control has a row of colour buttons corresponding to the row of coloured subjects on the screen.

Pressing one of the colour buttons will take you directly to the page corresponding to the subject heading.

## Digital Teletext (DTV Mode)

Digital teletext can access special digital teletext services and specific services which broadcast digital teletext. The subtitle will temporarily auto off when digital teletext function is turned on.

### Teletext within Digital Service

1. In DTV mode, press the **OK** button to display the Channel List. Press the **▲▼** buttons to select a channel with a **(TXT)** icon displayed.
2. Press the **TEXT** button to display the teletext page.
3. Press the **0-9** buttons to select a page number.
4. Follow the instructions on digital teletext and move onto the next step by pressing **OK**, **▲◀▶▼**, **RED**, **GREEN**, **YELLOW**, **BLUE** or the **0-9** buttons etc.
5. To change digital teletext service, select a different service by pressing the **0-9** buttons or the **▲▼** buttons.



## EPG (Electronic Programme Guide) (DTV Mode)

This system has an Electronic Programme Guide (EPG) to help you navigate through all the possible viewing options.

The EPG supplies information such as programme listings, start and end times for all available services. In addition, detailed information about the programme is often available in the EPG (the availability and amount of programme information will vary, depending on the particular broadcaster).

This function can be used only when the EPG information is broadcast by broadcasting companies.

The EPG displays the programme details for the next 7 days.

### Switch On/Off EPG

1. Press the **EPG** button to switch on EPG.
2. Press the **EPG** button or the **EXIT** button again to switch off EPG and return to normal TV viewing.

### Select a Programme

1. Press the **▲▼**, **CH +** or **CH -** buttons to select the desired channel and then press the **◀▶** buttons to select the desired programme. Press the **OK** button to confirm.



### Button Functions in a 7 Days Guide

Remote Control Button	Function
<b>RED</b>	Timer Programming See page 42 for details on <b>Timer Programming</b>
<b>GREEN</b>	Reminder Press this button while on the selected programme. The TV will automatically tune to the selected programme when it starts
<b>YELLOW</b>	- Day (To view schedule of the previous day)
<b>BLUE</b>	+ Day (To view schedule of the next day)
<b>▲ or ▼</b>	To select a channel
<b>◀ or ▶</b>	To view a programme's information
<b>OK</b>	To confirm and view the selected channel
<b>DISPLAY</b>	To preview the selected channel on the preview screen
<b>EPG / EXIT</b>	Switch off EPG

# My Album

1. Press the **SOURCE** button and select DTV mode and then press the **MEDIA** button.
2. Press the **▲▼** buttons and then press the **OK** button to select **My Album**.
3. Press the **BLUE** button to open the directory. Press the **▲▼** buttons to select your desired folder and then press the **OK** button to enter the folder. All picture files will be listed on the right.
4. Press the **▲▼** buttons to select the picture file and then press the **OK** button to view.



If the current folder has no photos, press the **OK** button or the **MENU** button to select **ROOT (USB)** to return to the root directory.  
File format supported: JPEG/BMP.

5. Press the **MEDIA** button to return to Thumbnail view. Press the **▲◀▶▼** buttons to navigate in the thumbnail view. Press the **OK** button to select the photo you want to view.
6. Press the **DISPLAY** button to display the function bar. Press the **RED** button to zoom in on the picture. Press the **GREEN** button to display the music folder, so you can play music at the same time. Press the **YELLOW** button to flip the photo horizontally. Press the **BLUE** button to flip the photo vertically. Press the **OK** button to start the slideshow.
7. During slideshow, press the **DISPLAY** button to display the function bar. Press the **RED** button to pause and press the **RED** button again to resume the slideshow. Press the **GREEN** button to display the music folder, so you can play music at the same time. Press the **YELLOW** button to set repeat mode of the slideshow. (Repeat Once / All) Press the **BLUE** button to select the transition speed of the slideshow. (Slow / Middle / Fast)
8. Press the **MENU** button or the **MEDIA** button to return to the previous menu.
9. Press the **EXIT** button to exit the menu.

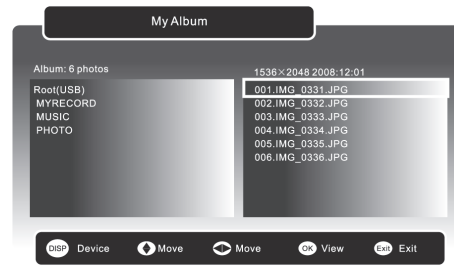
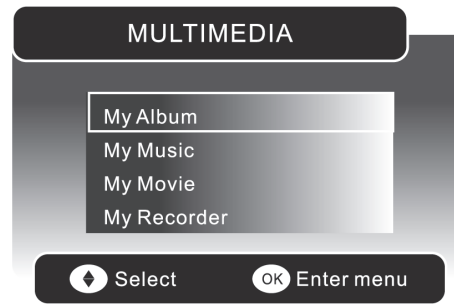

## My Music

1. Press the **SOURCE** button and select DTV mode and then press the **MEDIA** button.
2. Press the **▲▼** buttons and then press the **OK** button to select **My Music**.

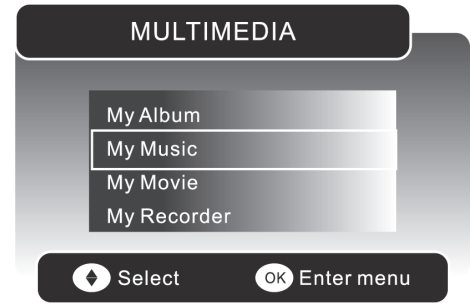

3. Press the **▲◀▶▼** buttons to navigate in the music folder. Select the music you want to play and then press the **OK** button to play it.



Some audio file formats will not be supported.

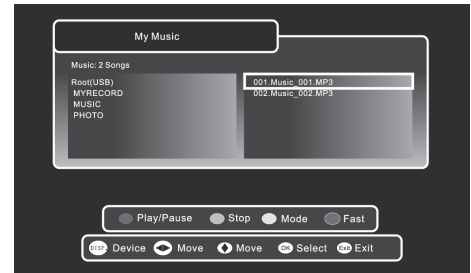

4. Press the **RED** button to pause the music playback and press again to resume the playback.  
Press the **GREEN** button to stop the music playback.  
Press the **YELLOW** button to set repeat mode of the music (Repeat All/ Repeat One/ NO Repeat).  
Press the **BLUE** button to fast forward the music playback.  
Press the **DISPLAY** button to switch to the device type menu.
5. Press the **MENU** button or the **MEDIA** button to return to the previous menu.
6. Press the **EXIT** button to exit the menu.

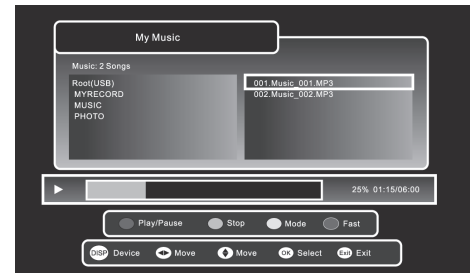

## My Movie

1. Press the **SOURCE** button and select DTV mode and then press the **MEDIA** button.
2. Press the **▲▼** buttons and then press the **OK** button to select **My Movie**.

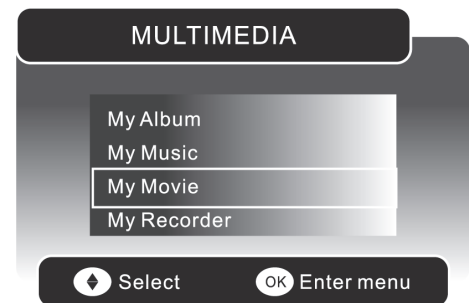

- If more than one USB storage device is connected, press the **DISPLAY** button to switch to the device type menu. Press the **▲◀▶▼** buttons to select the active device and then press the **OK** button to confirm.
- Press the **▲◀▶▼** buttons to navigate in the movie folder. Select the movie you want to play and then press the **OK** button to play it.



Some video file formats will not be supported.

- During the movie playback, press the **DISPLAY** button to display the function bar.  
Press the **RED** button to pause the movie playback. Press the **RED** button again to resume the playback.  
Press the **GREEN** button repeatedly to play the movie frame-by-frame. Press the **RED** button to resume the playback.  
Press the **YELLOW** button to set a fast-backward speed to view the movie. Press the **RED** button to resume the playback.  
Press the **BLUE** button to set a fast-forward speed to view the movie. Press the **RED** button to resume the playback.  
Press the **▲▼** buttons to view previous / next movie.
- Press the **MENU** button or the **MEDIA** button to return to the previous menu.
- Press the **EXIT** button to exit the menu.

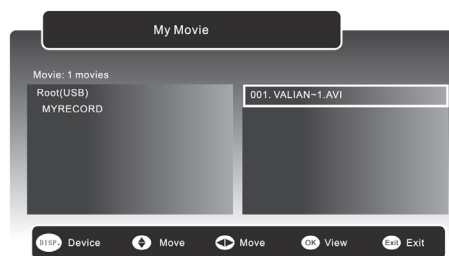

## My Recorder

- Press the **SOURCE** button and select DTV mode and then press the **MEDIA** button.
- Press the **▲▼** buttons and then press the **OK** button to select **My Recorder** to enter the **DVR SETUP** menu.

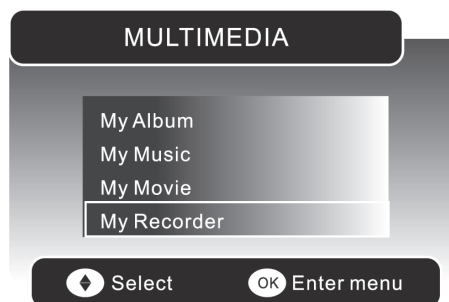

## Recorded List

You can play or delete from the recorded programme list.

- In the **DVR SETUP** menu, press the **▲▼** buttons and then press the **OK** button to select **Recorded List**.
- If more than one USB storage devices is connected, press the **DISPLAY** button to switch to the device type menu. Press the **▲◀▶▼** buttons to select the active device and then press the **OK** button to confirm.

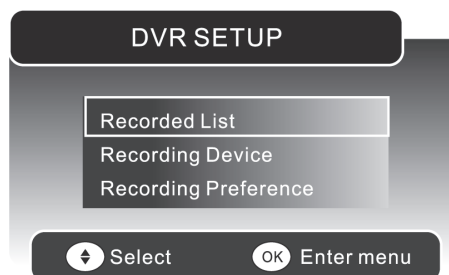

**To Play**

- In the Recorded List, press the ▲▼ buttons to select the recorded programme you want to view.
- Press the **GREEN** button to preview the recorded programme and then press the **OK** button to play the selected programme.



If the selected programme was stopped before it had finished the last time you viewed it, the "DVR PLAY OPTION" will pop up. Press the ▲▼ buttons to select between Play From Start / Play From Last Viewed. Press the **OK** button to confirm your selected option.

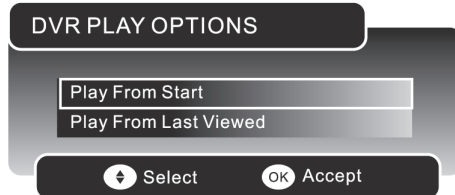

- During playback, press the **DISPLAY** button to display the DVR Playback Progress Bar. Press the ◀◀ or ▶▶ button to play the previous or next movie.

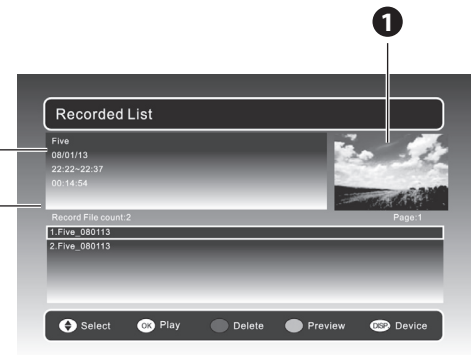
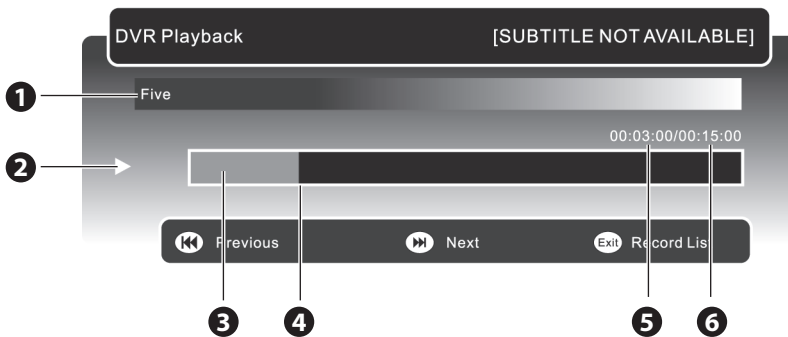

- Preview window for the recorded video selected
- Information of the recorded video selected
- Recorded video list

**The 'DVR Playback Progress Bar'**

- Indicates the programme's name
- Indicates the playback status of the recorded programme
- Indicates the status of the programme's runtime
- Indicates the current playback position
- Indicates the elapsed playback time
- Indicates the total playback time

**To Delete**

- Press the ▲▼ buttons to select the recorded programme you want to delete.
  - Press the **RED** button to delete the recorded programme and then press the **OK** button to confirm.
- Press the **MENU** button or the **MEDIA** button to return to the previous menu.
  - Press the **EXIT** button to exit the menu.

**Recording Device**

You can view the status of the storage device and select the device you wish to record to if there is more than one device connected.

- In the **DVR SETUP** menu, press the ▲▼ buttons and then press the **OK** button to select **Recording Device**.

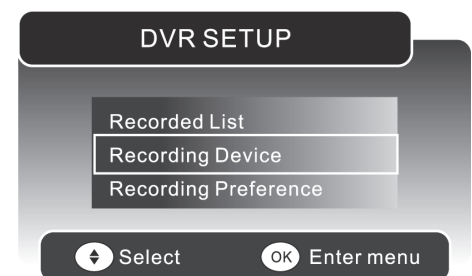

- Press the ▲◀▶▼ buttons to adjust the settings.

<b>Device Type</b>	Indicates that a USB device is connected.
<b>Slot</b>	Select the active USB storage device connected to the USB hub slot (1 → 2 → 3 → 4).
<b>Partition</b>	Select the active partition (1 → 2 → ... → max.15) on the selected USB device.

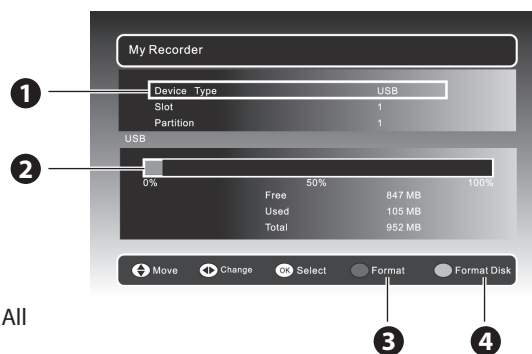

- Press the **RED** button to select **Format**. Press the **OK** button to confirm. All data will be lost from the formatted partition.  
Press the **GREEN** button to select **Format The Disk**. Press the **OK** button to confirm. All data will be lost from the disk.

Formatting may be needed occasionally due to a hard disk malfunction. In most cases, this will restore normal operation of the hard disk, however all data previously stored will be lost.

- Press the **MENU** button or the **MEDIA** button to save the settings and return to the previous menu.
- Press the **EXIT** button to exit the menu.

## Recording Preference

- In the **DVR SETUP** menu, press the ▲▼ buttons and then press the **OK** button to select **Recording Preference**.

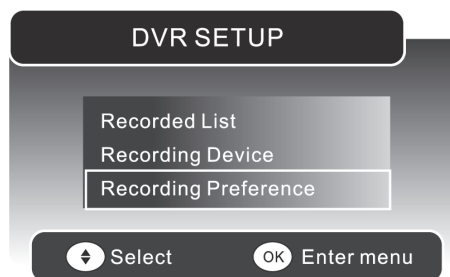

- Press the ▲◀▶▼ buttons to adjust the settings.

<b>Time Shift Size</b>	The minimum USB's time shift size is 768MB. The time shift size will vary depending on the size of USB storage device.
<b>Time Shift</b>	Set the time shift recording Off/ Pause/ Auto.
<b>One Button Recording</b>	Set the one button recording on /off.
<b>Default Record Duration</b>	The longest recording duration is 8 hours. The shortest recording duration is 15 minutes.

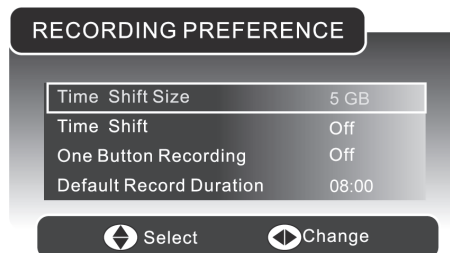

- Press the **MENU** button or the **MEDIA** button to save the settings and return to the previous menu.
- Press the **EXIT** button to exit the menu.

Only DTV programmes can be recorded by DVR. During recording, you can change to another input source (except TV mode) without affecting the recording progress.  
Copy-protected programmes may not be recorded.  
Recording a programme for an hour would approximately take up 2G of storage space, when the DTV video rate is 5Mbps. (For reference only)

Hard disk size	Approximate hour can be recorded
40 GB	20 hrs
80 GB	40 hrs
160 GB	80 hrs
320 GB	160 hrs
640 GB	320 hrs
1 TB	500 hrs

## Time Shift Function

This function allows the TV to automatically record live TV and make it available for viewing at any time. With the Time Shift Mode set to **Auto** or **Pause**, you may pause or rewind normal TV viewing at any time without missing any of the live broadcast.



- To set Time Shift mode, please refer to the **Recording Preference** on page 39 for details.
- Time Shift Mode and Recording functions may not work if the signal strength is weak.

### Auto Time Shift Mode

During the normal TV viewing, you may press the **▶||** button to virtually pause the live viewing broadcast programme if you want to go out for a while (e.g. going to the bathroom / kitchen). When you have returned, press the **▶||** button to play the missed broadcast programme. The DVR Time Shift progress bar will be displayed on the screen.

In other circumstances, you may just leave the TV for a while without pressing any buttons. When you have returned, press the **◀◀** button to virtually rewind the live viewing broadcast programme. Press the **▶||** button to play the missed broadcast programme. The DVR Time Shift progress bar will be displayed on the screen.

### Pause Time Shift Mode

During the normal TV viewing, you may press the **▶||** button to virtually pause the live viewing broadcast programme if you want to go out for a while (e.g. going to the bathroom / kitchen). When you have returned, press the **▶||** button to play the missed broadcast programme. The DVR Time Shift progress bar will be displayed on the screen.

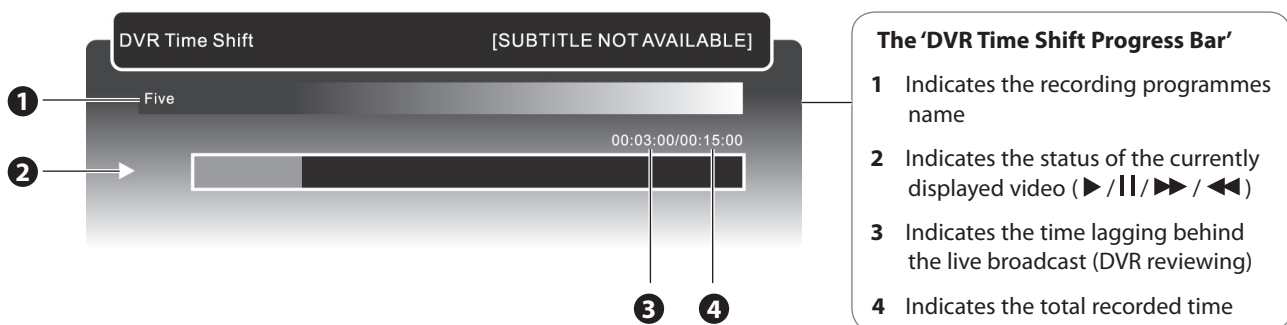

The progress bar will hide automatically after 3 seconds. Press **DISPLAY** button to display the DVR Time Shift progress bar again.

### Using the remote control

You can shift playback to any point within the recorded programme.

◀◀ or ▶▶	<p>When playing,</p> <ul style="list-style-type: none"> <li>• press the <b>◀◀</b> button repeatedly to speed up <b>◀◀</b> x 2 / x 4 / x 8 / x 16 / x 32.</li> <li>• press the <b>▶▶</b> button repeatedly to speed up <b>▶▶</b> x 2 / x 4 / x 8 / x 16 / x 32.</li> <li>• During fast forward / fast backward state, press the <b>▶  </b> button to return to normal playback.</li> </ul>
◀◀◀ or ▶▶▶	<ul style="list-style-type: none"> <li>• Press the <b>▶▶▶</b> button to jump about 10% forward.</li> <li>• Press the <b>◀◀◀</b> button to jump about 10% back.</li> </ul>
▶	<ul style="list-style-type: none"> <li>• During playback, press the <b>▶  </b> button to display a still screen and then press the <b>▶  </b> button again to resume playback.</li> <li>• During playback, press the <b>▶  </b> button and then press the <b>▶▶</b> button for slow motion.</li> <li>• During fast forward / fast backward state, press the <b>▶  </b> button to return to normal playback.</li> </ul>
■	<p>If you want to exit the DVR Time Shift progress bar and return to the current live broadcast, press the <b>■</b> button.</p>



# Recording DTV Programme onto a USB Storage Device

Use this function to record the DTV programme you are watching on the main screen and save them for future viewing.

You may use the DVR Time Shift function during recording to view the recorded programme instantly. Please refer to the section "Time Shift Function" for detail.

1. Press the **SOURCE** button and select DTV mode and then press the **MEDIA** button.
2. Press the **▲▼** buttons and then press the **OK** button to select **My Recorder** to enter the DVR SETUP menu.
3. In the DVR SETUP menu, press the **▲▼** buttons and then press the **OK** button to select **Recording Preference**.

## Method 1

1. Press the **▲▼** buttons to select **One Button Recording** and set it to On.
2. Press the **▼** button to set the **Default Record Duration** (preset configuration). Press the **◀▶** buttons to set the recording duration. The longest recording duration is 8 hours, the shortest recording duration is 15 minutes.
3. Press the **EXIT** button to exit the menu and return back to the main screen you were watching.
4. Press the **REC** button on the remote control to start recording. The current recording status will be displayed in the top left hand corner of the screen.
5. To stop recording, press the **■** button and then press the **OK** button to confirm.

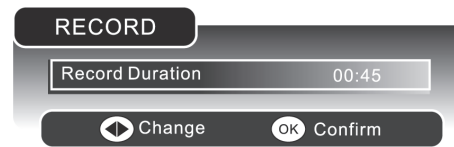
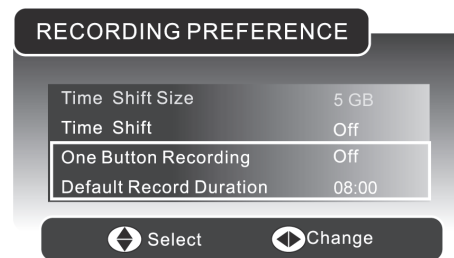

## Method 2

1. If the **One Button Recording** is set to Off.
2. While you are watching the main screen, press the **REC** button on the remote control. Press the **◀▶** buttons to set the record duration. The Record Duration menu will be displayed. The longest record duration is 8 hours, the shortest record duration is 15 minutes.
3. Press the **OK** button to confirm and start recording. The current recording status will be displayed in the top left hand corner of the screen.
4. To stop recording, press the **■** button and then press the **OK** button to confirm.

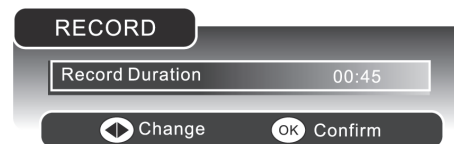
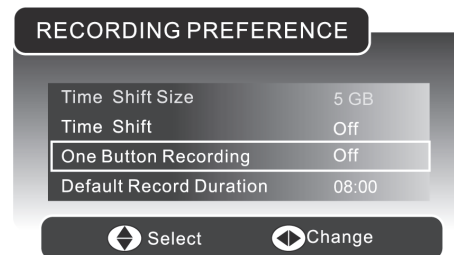

Recording will stop automatically when the disk is full.

## Timer Programming

This function is used to perform scheduled recording.

1. Press the **EPG** button on the remote control. The **EPG** menu will appear.



2. Press the **RED** button on the remote control to enter the Timer Programming menu.



### Alternative

1. You may press the **MENU** button and then use the **▲▼** buttons to select the **DTV** menu and then press the **▶** button.
2. Press the **▲▼** buttons to select **TIMER** and then press the **OK** button or the **▶** button to enter the **TIMER PROGRAMMING** menu.

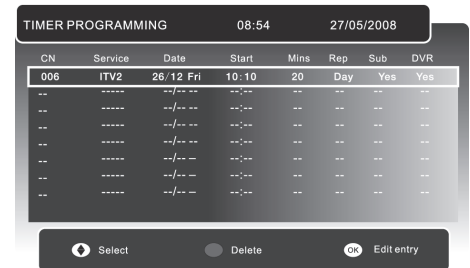

3. Press the **OK** button to enter the **Enter Details** menu for recording setting.

<b>CN</b>	Input / Select the channel no.
<b>Date</b>	Set the recording date
<b>Time</b>	Set the starting time of recording
<b>Duration</b>	Set the duration of recording
<b>DVR</b>	Set <b>YES</b> for programme recording and <b>NO</b> for programme reminder.
<b>Repeat</b>	Set repeat function among Daily / Weekly / Mon-Fri / Mon-Sat / NO
<b>Subtitles</b>	Set subtitles to be included during recording

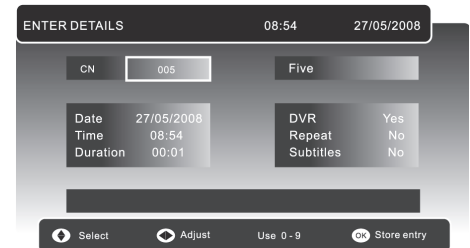

4. Press the **▲▼** buttons to select CN / Date / Time / Duration / DVR / Repeat / Subtitles.
5. Press the **◀▶** buttons for adjustment.
6. Press the **OK** button to save the setting.



If a programme recording starts when the TV is in standby mode, the blue LED indicator will illuminate.

## Using the Built-in DVD Player

1. Press the **SOURCE** button and select **DVD** mode.
2. Insert a disc with label side facing backward to you. (CD-R, CD-RW, DVD-R, DVD-RW, CD, DVD+R, or DVD+RW). Allow 10 seconds for the player to load the disc.
3. After the disc is inserted, Smart NAVI will show the content of the disc automatically.
4. If the DVD player does not automatically play the disc, press the **▶▶** button on the remote control to start playing.
5. Press the **▲** button if you want to remove the disc.

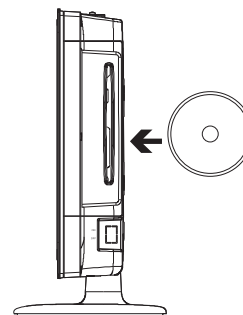

Only insert 12cm discs. Do not insert or play 8cm discs. They will get stuck.

## Compatible Disc Types

Disc Types	Disc Logo	Recorded Content
DVD-VIDEO (Digital Versatile Disc)		AUDIO + VIDEO
DVD±RW (Audio/Video format or JPEG files)		AUDIO + VIDEO + JPEG
DVD±R (DVD Recordable - Audio/Video format or JPEG files)		AUDIO + VIDEO + JPEG
CD-R (CD Recordable - Audio/Video format or JPEG files)		AUDIO + VIDEO + JPEG
CD-RW (CD-Rewritable - Audio/Video format or JPEG files)		AUDIO + VIDEO + JPEG
AUDIO-CD (Compact Disc Digital Audio)		AUDIO

## Supported Formats

### JPEG

- The file extensions has to be .jpg and not .jpeg
- Pictures encoding must comply with JPEG/ISO format.
- This DVD player can only display DCF-standard still pictures or JPEG pictures such as TIFF.



Some recorded files may not be able to be played due to the type and format of disc or condition of the recording.

## Region Code

Both the DVD player and the discs are coded by region. These regional codes must match in order to play the disc. If the codes do not match, the disc will not play.

The Region Number for this DVD player is described on the rear panel of the DVD player.

Disc Type	DVD-VIDEO
Region code	

## Basic DVD Playback Functions

### Playing the DVD

Depending on the disc, a menu may appear on the TV screen once the disc has loaded. When playing the disc, you may use the **▶||** button to toggle between Play and Pause mode. This product also supports Menu / Title / Sequential / Program Playback.

### Menu Playback (for DVD)

For DVD discs, the screen will display the DVD Disc Menu (Root Menu).

Press the **OK** button or the **▶||** button to start from the highlighted content.

Press the **DVD MENU** button to return to the Root Menu when playing the disc.

For some DVD discs you may need to press the **DVD MENU** button or the **TITLE** button to display the Disc Menu.

### Stopping Playback

Press the **■** button once to stop. Press the **▶||** button to resume from where you stopped.

Press the **■** button twice to stop. Press the **▶||** button to start from the beginning.

In order to protect the disc, press the **■** button and then press the **▲** button to eject the disc. When the disc is ejected, hold the disc edge slightly and remove it from the disc slot.

When not using the DVD function (in stand-by-mode or using others modes for a long period of time), please take out the disc to protect the DVD loader and the disc.

### Previous / Next (for DVD / CD / Multimedia discs)

Press the **◀◀** button to play the last Title / Chapter / Track.

Press the **▶▶** button to play the next Title / Chapter / Track.



If the current track is the first one, pressing the **◀◀** button will stop the playback.

If the current track is the last one, pressing the **▶▶** button will stop the playback.

For DVD discs, the above functions may vary due to different DVD disc's structure.

### Forward / Backward (for DVD / CD / Multimedia discs)

There are 4 speeds for forward. Press the **▶▶** button to toggle between different forward options in sequence. (FORWARD x 2 / FORWARD x 4 / FORWARD x 8 / FORWARD x 20 / Play).

Press the **▶||** button to resume normal speed.

For DVD discs, when selecting backward to first title / chapter, the disc will start from the beginning.



The sound will be off during Forward or Backward.

### Pause (for DVD / CD / Multimedia discs)

- For CD / JPEG discs, press the **▶||** button to pause; press the **▶||** button again to resume.
- For DVD discs, press the **▶||** button to pause; press the **▶||** button again to resume.

### Repeat (for DVD / CD / Multimedia discs)

Press the **REPEAT** button once to display the current repeat mode.

- For CD discs, while playing in sequence, you may use the repeat playback. There are 2 repeat modes, press the **REPEAT** button to toggle between different repeat modes in sequence. (REPEAT (OFF) / REPEAT (1) / REPEAT (ALL)).
- For DVD discs, you may setup the repeat playback mode. There are 3 repeat modes, press the **REPEAT** button to toggle between different repeat modes in sequence. (REP: (OFF) / REP: (CHAPTER) / REP: (TITLE) / REP: (ALL)).
- For MP3 / JPEG discs, while playing the disc, you may use the repeat playback. There are 3 repeat modes, press the **REPEAT** button to toggle between different repeat modes in sequence. (REPEAT (OFF) / REPEAT (1) / REPEAT (DIR) / REPEAT (ALL)).

## Info (for DVD / CD / Multimedia discs)

Press the **INFO** button to activate the on screen roll-down menu for the current Title, Chapter, Time and other information.

For DVD discs, press the **INFO** button once to display the first page as shown below:

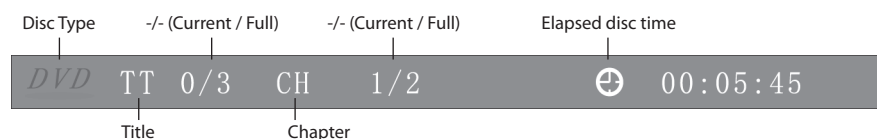

Press the **INFO** button again to display the second page as shown below:

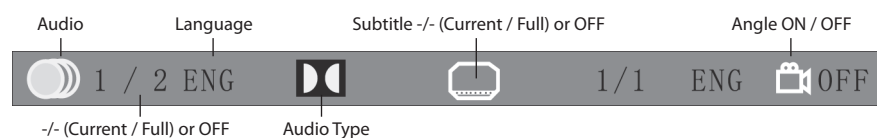

Press the **INFO** button repeatedly to turn off the on screen display.

For CD / JPEG discs, press the **INFO** button once to display first page: Disc type, Track -/- (Current / Full), Mute status, Repeat mode status, Current track time.

Press the **INFO** button repeatedly to turn off the screen display.

## Goto (for DVD / CD / Multimedia discs)

This function allows you to play your favorite Title / Chapter / Track. Press the **GOTO** button to activate the on screen scroll-down menu for selecting. Input your Title / Chapter / Track number by **0-9** buttons or input the playback time. After editing, press the **OK** button to start. If the input is invalid, it will not function.

## Audio (for DVD / CD)

Press the **AUDIO** button once to display current audio mode.

Press again to toggle between different audio modes in sequence.

For CD discs: Stereo / MonoL / MonoR



Some disc may contain multi-languages which can be selected by pressing the **AUDIO** button.

## Repeat A-B (for DVD / CD)

When playing DVD, CD disc, press the **A-B** button to repeat certain content. Press the **A-B** button on the start point (A) and the end point (B) to select the repeat part. Press the **A-B** button a third time to cancel the **A-B** button function and return to normal playback.

## Playing Multimedia Discs

After loading the multimedia disc, the disc contents will automatically be displayed and sorted by different file formats into Music / Picture / Video folders.

Press the **▲◀▶▼** buttons to navigate through the folders and files.

Press the **0-9** buttons to select the contents directly. For numbers over 10, press the **10+** button first. (e.g. File number 15, press 10+ then 5.)

When playing or pausing with picture playback, you may use the **▲◀▶▼** buttons to flip / rotate the picture.

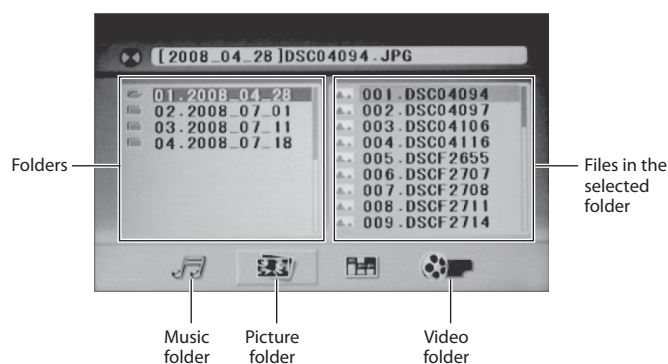







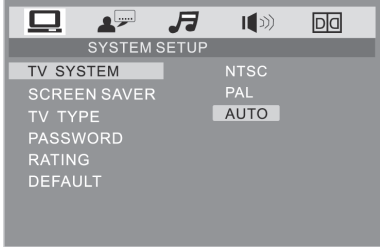

## Using the DVD System Setup Page

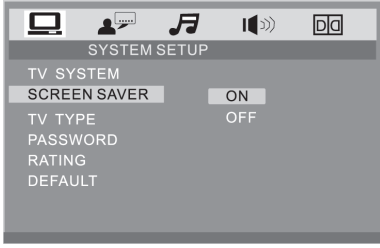
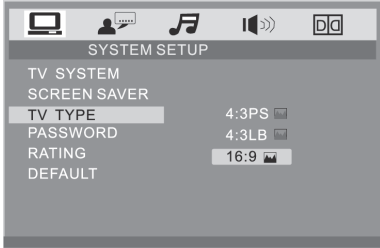
In the DVD mode, press the **DVD SETUP** button on the remote control. Press the ◀▶ buttons to select the **System Setup** menu, and the ▲▼ buttons to select the menu options. Press the **DVD Setup** button to exit the menu.

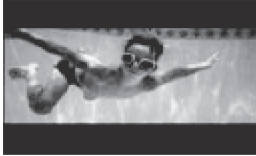

In Setup mode, the disc playback function will not be available.

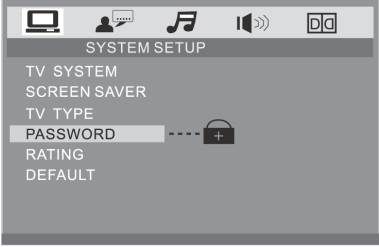
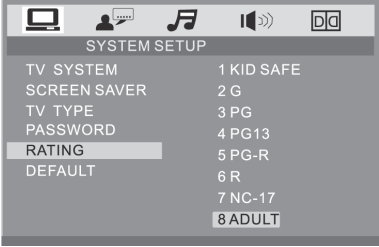

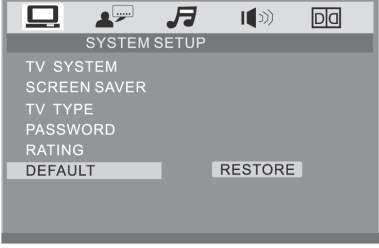
	Option	Description
	<b>TV SYSTEM</b>	<p>In order for the disc to play, the colour system of the DVD player, disc and TV should match.</p> <p><b>NTSC</b> This format is used by some other countries, e.g. USA.</p> <p><b>PAL</b> This is the format used in UK.</p> <p><b>AUTO</b> This format can be used if your TV / DVD is capable of both PAL and NTSC formats and this is the default setting.</p> <p> PAL format is generally used for TV's in the UK. If NTSC is selected with a non-compatible television, you may experience interference or picture scrolling.</p>
		<b>SCREEN SAVER</b>
	<b>TV TYPE</b>	<p><b>4:3 Pan Scan</b> Widescreen picture shown in the full screen with some part cut.</p>  <p><b>4:3 Letter box</b> Widescreen picture shown in the full screen with black bars on the top and bottom of the screen.</p>  <p><b>16:9</b> Widescreen picture shown in the full screen.</p> 





	Option	Description
	<b>PASSWORD</b>	<p><b>PASSWORD MODE</b> Select to change old password to new password. (Factory default is 0000)</p> <p><b>PASSWORD CHANGE</b> To change the password, you need to:</p> <ol style="list-style-type: none"> <li>1. Input old password.</li> <li>2. Input a new 4 digit password.</li> <li>3. Input the new password again to confirm.</li> </ol>
	<b>RATING</b>	<p><b>RATING</b> Allows the user to set a maximum rating level for a movie that can be played (e.g. PG rating). Movies rated higher than the level set will not be played. The parental lock can only be changed after inputting the correct password.</p> <p> This function is available only when the discs have ratings encoded on them.</p>
	<b>DEFAULT</b>	<p><b>DEFAULT</b> To restore all setup parameters to the factory settings EXCEPT the password. This function is available in stop state or when the tray is opened.</p>

## Using the DVD Language Setup Page

In the DVD mode, press the **DVD SETUP** button on the remote control. Press the ◀▶ buttons to select the **Language Setup** menu, and the ▲▼ buttons to select the menu options. Press the **DVD Setup** button to exit the menu.

 In Setup mode, the disc playback function will not be available.



	Option	Description
	<b>AUDIO LANG</b>	<p>Set the audio language to your language of choice.</p> <p> Not all DVD discs support multiple audio languages.</p>

Option	Description
	<b>SUBTITLE LANG</b> <b>SUBTITLE</b> Select the Subtitle language.  Not all DVD's offer subtitles in multiple languages.
	<b>MENU LANG</b> <b>DISC MENU</b> Select the Disc Menu language.  The default language is English.

## Using the DVD Audio Setup Page

In the DVD mode, press the **DVD SETUP** button on the remote control. Press the ◀▶ buttons to select the **Audio Setup** menu, and the ▲▼ buttons to select the menu options. Press the **DVD Setup** button to exit the menu.

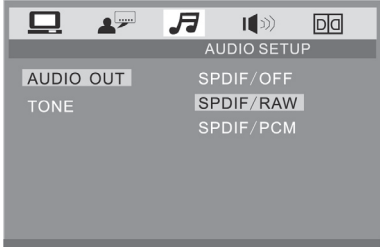
 In Setup mode, the disc playback function will not be available.

Option	Description
	<b>AUDIO OUT</b> <b>SPDIF OFF</b> Set as default, there will be no digital audio signal output. <b>SPDIF RAW</b> Set as default, the digital audio signal output will be in RAW format. Normally, this mode is used for DTS signal and Dolby digital signal. <b>SPDIF PCM</b> Set as default, the digital audio signal output will be in PCM format. Normally, this mode is use for audio CD signal.
	<b>TONE</b> Adjust the tone setting.



## Using the DVD Speaker Setup Page

In the DVD mode, press the **DVD SETUP** button on the remote control. Press the ◀▶ buttons to select the **Speaker Setup** menu, and the ▲▼ buttons to select the menu options. Press the **DVD Setup** button to exit the menu.



In Setup mode, the disc playback function will not be available.

	Option	Description
	<b>AUDIO OUT</b>	<p><b>LT/RT</b> Select this option when the DVD player is connected to an external amplifier with Pro-Logic decoding function.</p> <p><b>STEREO</b> Press the ▼ button to select <b>STEREO</b> and then press the <b>OK</b> button to confirm.</p> <p><b>VSS</b> Press the ▼ button to select <b>VSS</b> (Virtual Surround Sound) and then press the <b>OK</b> button to confirm.</p>

## Using the DVD Dolby Digital Setup Page

In the DVD mode, press the **DVD SETUP** button on the remote control. Press the ◀▶ buttons to select the **Digital Setup** menu, and the ▲▼ buttons to select the menu options. Press the **DVD Setup** button to exit the menu.



In Setup mode, the disc playback function will not be available.

	Option	Description
	<b>DYNAMIC RANGE</b>	<p>When the dynamic range is set to FULL, the audio level during quiet and loud parts of the movie will be automatically adjusted.</p> <p> This setting is used to play Dolby Digital encoded discs. Best used for night time viewing.</p>
	<b>DUAL MONO</b>	<p><b>STEREO</b> The player will output both left channel and right channel audio.</p> <p><b>MONO L</b> It means that the player will output left channel audio only.</p> <p><b>MONO R</b> The player will output right channel audio only.</p> <p><b>MIX MONO</b> The player will output the average signal of the left channel and right channel audio.</p> <p> This setting is used to play Dolby AC-3 encoded 2 channel discs. This setting may not be adjustable for some discs.</p>

## Maintenance

Careful and regular cleaning can prolong the life of your TV.



Be sure to switch off the **POWER ON/OFF** switch and disconnect the mains cable from the mains socket before you start any cleaning.

1. Use a soft dry cloth to wipe away the dust from the screen and surfaces.
2. If the surfaces are extremely dirty, clean the TV with a cloth which has been dipped in a weak soapy water. Wring the cloth until it is almost dry, then use it to wipe the TV.
3. Ensure there is no excess water on the screen. Allow any water or dampness to evaporate before switching the TV on.

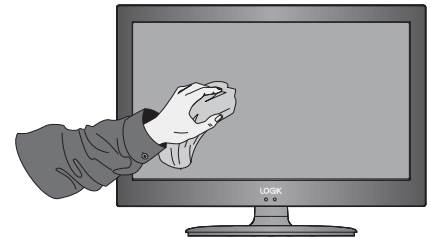

Never use alcohol, benzene, paint-thinner, cleaning fluid or other chemicals. Do not use compressed air to remove dust.

## Handling Discs

- Do not touch the playback side of the disc.
- Do not attach paper or tape to the disc.

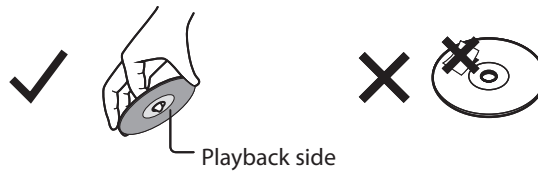

## Cleaning Discs

- Fingerprints and dust on the disc cause picture and sound deterioration. Wipe the disc from the centre outwards with a soft cloth. Always keep the disc clean.



- If you cannot wipe off the dust with a soft cloth, wipe the disc lightly with a slightly moistened soft cloth and finish with a dry cloth.
- Do not use any type of solvent such as thinner, benzene, commercially available cleaners or antistatic spray. They may damage the disc.

## Storing Discs

- Do not store discs in places subjected to direct sunlight or near heat sources.
- Do not store discs in places subjected to moisture and dust such as a bathroom or near a humidifier.
- Storing discs vertically in a case, stacking discs or placing objects on discs outside of their cases may cause warping.

## Hints and Tips

If a problem does occur, it may often be due to something very minor. The following table contains various tips.

The TV does not operate properly.	
<b>The remote control does not work</b>	<ul style="list-style-type: none"> <li>• Check to see if there are any objects between the TV and the remote control causing an obstruction. Ensure that you are pointing the remote control directly at the TV.</li> <li>• Ensure that the batteries are installed with correct polarity (+ to +, - to -).</li> <li>• Install new batteries.</li> </ul>
<b>Power is suddenly turned off</b>	<ul style="list-style-type: none"> <li>• Check the power of the TV. The mains supply maybe interrupted.</li> <li>• Check if the sleep timer is set.</li> <li>• Check whether the Auto Sleep is activated.</li> </ul>

The video function does not work.	
<b>No Picture &amp; No Sound</b>	<ul style="list-style-type: none"> <li>• Check whether the TV is switched on.</li> <li>• Try another channel. The problem may be caused by the broadcaster.</li> </ul>
<b>Picture appears slowly after switching on</b>	<ul style="list-style-type: none"> <li>• This is normal, the image is muted during the TV startup process. Please contact your service centre, if the picture has not appeared after five minutes.</li> </ul>
<b>No or poor colour or poor picture</b>	<ul style="list-style-type: none"> <li>• Adjust the settings in the <b>PICTURE</b> menu.</li> <li>• Try another channel. The problem may be caused by the broadcaster.</li> <li>• Check if the video cables are connected properly.</li> </ul>
<b>Horizontal / Vertical bar or picture shaking</b>	<ul style="list-style-type: none"> <li>• Check for local interference such as an electrical appliance or power tool.</li> </ul>
<b>Poor reception on some channels</b>	<ul style="list-style-type: none"> <li>• Station or cable channel may be experiencing problems, tune to another station.</li> <li>• Station signal is weak, reposition the aerial for better reception.</li> <li>• Check for sources of possible interference.</li> </ul>
<b>Lines or streaks in pictures</b>	<ul style="list-style-type: none"> <li>• Check aerial (Change the position of the aerial.)</li> </ul>
<b>No pictures when connecting HDMI</b>	<ul style="list-style-type: none"> <li>• Check if the input source is <b>HDMI</b>.</li> </ul>

The audio function does not work.	
<b>Picture OK but no sound</b>	<ul style="list-style-type: none"> <li>• Press the <b>VOL + / -</b> buttons.</li> <li>• Sound muted? Press the <b>MUTE</b> button.</li> <li>• Try another channel. The problem may be caused by the broadcaster.</li> </ul>
<b>No output from one of the speakers</b>	<ul style="list-style-type: none"> <li>• Adjust the <b>Balance</b> settings in the <b>SOUND</b> menu.</li> </ul>
<b>Unusual sound from Inside the TV</b>	<ul style="list-style-type: none"> <li>• A change in ambient humidity or temperature may result in an unusual noise when the TV is switched on or off and does not indicate a fault with the TV.</li> </ul>
<b>No sound when connecting HDMI</b>	<ul style="list-style-type: none"> <li>• Check if the input source is <b>HDMI</b>.</li> </ul>
<b>Audio noise</b>	<ul style="list-style-type: none"> <li>• Keep the RF coaxial cable away from the other connected cables.</li> </ul>

Password	
<b>Lost password</b>	<ul style="list-style-type: none"> <li>• Select the <b>Child Lock</b> setting in the <b>FUNCTION</b> menu, then enter the following master password "8899". The master password clears your previous password and allows you to enter a new password.</li> </ul>

The DVR function does not work.	
<b>One button recording / timer programming does not work</b>	<ul style="list-style-type: none"> <li>• Check if the TV is in DTV mode.</li> <li>• Check the connection of the external USB storage device.</li> <li>• Check if the capacity of the USB storage device is full.</li> </ul>

**There is a problem in PC mode.****The signal is out of range (Invalid format)**

- Adjust resolution, horizontal frequency, or vertical frequency.

**Vertical bar or stripe on background & Horizontal Noise & Incorrect position**

- Use Auto configure or adjust clock, phase, or H/V position.

**Screen colour is unstable or single colour**

- Check the signal cable.
- Reinstall the PC video card.

**The DVD function does not work.****DVD will not read the disc**

- Check if the disc is correctly inserted.
- Check that the disc is clean.
- Check if there is any obvious damage to the disc.
- Try to play the disc on another DVD to check whether it has content.

**DVD does not have the signal**

- Check if the TV is in DVD mode.

**FAQs (Frequently Asked Questions)****Why have I lost some/all of my channels?**

- It happens sometimes, if you have a weak signal. Usually it just means you'll need to rescan your digital box or TV. Don't worry, it's easy to do. And once you've done it, you should get all the Freeview channels available to you. If problems persist you may need to get your aerial checked. Talk to your retailer or contact your local aerial installer.

**Why do I get 'blocking' on my digital picture?**

- In most cases, blocking is caused by a reception problem - either the signal is too weak or there is some kind of interference. Talk to your retailer or contact your local aerial installer.
- Blocking can also be caused by a digital signal that is too strong. If you are still experiencing blocking and the signal is strong, consult your local aerial installer for advice.

**Can I watch Freeview using a portable set-top aerial?**

- Some, but only a few, homes may be able to use a set top aerial. However, for a much better reception, we strongly recommend that you use a rooftop aerial.
- If you do not have access to a rooftop aerial - for example, if you rent a flat and the aerial is the responsibility of your landlord, or if you're using a second TV in the bedroom and don't want the hassle and expense of using extension cables - a set-top aerial may be your only option.

**What type of aerial do I need?**

- If you are installing a new aerial, we recommend a wideband rooftop aerial rather than a loft aerial. Loft aerials generally receive a weaker digital signal and are more likely to get interference from other electrical devices in the home. We suggest you have an aerial survey done before getting an aerial upgrade.
- Talk to your retailer or contact your local aerial installer.

## Display Modes

The screen resolution has been optimised during production for the display modes listed below.

Whilst the TV is capable of accepting a 1080p input, it is not capable of displaying this screen resolution and therefore the display will be scaled to fit the native resolution of the screen automatically.

### YPbPr Mode

Resolution	Vertical Frequency (Hz)	Aspect Ratio
480I: 720 x 480	60	Full, 4:3
480P: 720 x 480		Full, 4:3
576I: 720 x 576	50	Full, 4:3
576P: 720 x 576		Full, 4:3
720P: 1280 x 720	50	Full, 4:3
	60	
1080I: 1920 x 1080	50	Full, 4:3
	60	Full, 4:3
1080P: 1920 x 1080	50	Full, 4:3
	60	Full, 4:3

### PC Mode

Please check the display settings of your computer before connecting to the TV. If the display setting of your computer does not match the TV, there may be no video.

Resolution	Vertical Frequency (Hz)	Aspect Ratio
640 x 480	60	Full
	72	
	75	
800 x 600	60	Full
	72	
	75	
1024 x 768	60	Full
	70	
	75	
1920 x 1080	60	Full

### HDMI Mode

Resolution	Vertical Frequency (Hz)	Aspect Ratio
480I: 1440 x 480	60	Full, 4:3
480P: 720 x 480	60	Full, 4:3
576I: 1440 x 576	50	Full, 4:3
576P: 720 x 576	50	Full, 4:3
720P: 1280 x 720	50	Full, 4:3
	60	
1080I: 1920 x 1080	50	Full, 4:3
	60	
1080P: 1920 x 1080	50	Full, 4:3
	60	

## Specification

<b>Model</b>	<b>L22DVDB10</b>
<b>Panel System</b>	21.6 inch LCD panel
<b>Display Resolution</b>	1920 pixels (horizontal) x 1080 pixels (vertical)
<b>Television System</b>	PAL I/BG/DK, SECAM L/BG/DK
<b>Brightness</b>	200-280 cd/m <sup>2</sup>
<b>Contrast Ratio</b>	700-1000:1
<b>Inputs/Output</b>	
<b>SCART</b>	1
<b>HDMI</b>	1
<b>VGA</b>	1
<b>PC AUDIO</b>	1
<b>S-VIDEO</b>	1
<b>YPbPr</b>	1
<b>CI</b>	1
<b>USB</b>	1
<b>DVD</b>	1
<b>VIDEO IN (RCA)</b>	1
<b>AUDIO IN (RCA)</b>	1 (L + R)
<b>COAXIAL</b>	1
<b>RF (75 Ω)</b>	1
<b>Speaker Power</b>	3 W + 3 W
<b>Earphone (3.5mm)</b>	1
<b>Power Source</b>	100V-240V~50/60Hz
<b>Dimension( W x D x H) with base</b>	526 x 200 x 372 mm
<b>Weight (Net)</b>	5.5 kg

Features and Specifications are subject to change without notice.

## Safety Warnings

- Read all the instructions carefully before using the unit and keep them for future reference.
- Retain the manual. If you pass the unit onto a third party make sure to include this manual.
- Check that the voltage marked on the rating label matches your mains voltage.

### Damage

- Please inspect the unit for damage after unpacking.
- Do not continue to operate the unit if you are in any doubt about it working normally, or if it is damaged in any way - switch off, withdraw the mains plug and consult your dealer.

### Location of Unit

- The unit must be placed on a flat stable surface and should not be subjected to vibrations.
- Do not place the unit on sloped or unstable surfaces as the unit may fall off or tip over.
- The mains socket must be located near the unit and should be easily accessible.
- This unit is designed for indoor use only.

### Temperature

- Avoid extreme degrees of temperature, either hot or cold. Place the unit well away from heat sources such as radiators or gas/electric fires.
- Avoid exposure to direct sunlight and other sources of heat.

### Naked Flames

- Never place any type of candle or naked flame on the top of or near the unit.

### Moisture

- To reduce the risk of fire, electric shock or product damage, do not expose this unit to rain, moisture, dripping or splashing. No objects filled with liquids, such as vases, should be placed on the unit.
- If you spill any liquid into the unit, it can cause serious damage. Switch it off at the mains immediately. Withdraw the mains plug and consult your dealer.

### Ventilation

- To prevent the risk of electric shock or fire hazard due to overheating, ensure that curtains and other materials do not obstruct the ventilation vents.
- Do not install or place this unit in a bookcase, built-in cabinet or in another confined space. Ensure the unit is well ventilated.
- Make sure that there is a gap of at least 10 cm on both sides and a gap of 20 cm at the top.

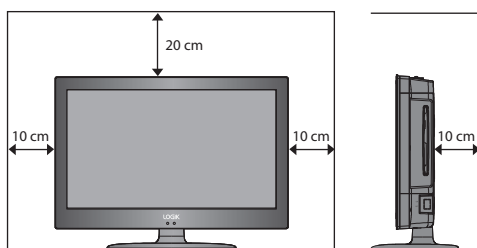

### Safety

- Always disconnect the unit from the mains supply before connecting/disconnecting other devices or moving the unit.
- Unplug the unit from the mains socket during a lightning storm.

### Mains Cable

- Make sure the unit or unit stand is not resting on top of the mains cable, as the weight of the unit may damage the mains cable and create a safety hazard.
- If the mains cable is damaged it must be replaced by the manufacturer, its service agent, or similarly qualified persons in order to avoid a hazard.

### Interference

- Do not place the unit on or near appliances which may cause electromagnetic interference. If you do, it may adversely affect the operating performance of the unit, and cause a distorted picture or sound.

### Optimum viewing

- View the unit in moderate light to prevent eye strain. It is recommended to watch the unit from a distance 3-7 times that of the screen height.

### LCD screen

- The LCD screen is manufactured using high-precision technology. However, some tiny black points and/or bright points (red, blue or green in colour) may constantly appear on the LCD screen. These points are generated in the manufacturing process and are normal.

### Screen Burn

- A characteristic of Plasma and LCD TV Panels is that displaying the same image for a long time may cause a permanent after-image to remain on the screen. This is called screen burn. Most pictures shown on the unit will be constantly moving and fill the screen.
- Examples of images that you need to watch out for are as follows (this is not an all-inclusive list):
  1. **Black Bars:** If black bars appear at the left/right or top/bottom of the screen, it is recommended to change the format so that the picture fills the entire screen.
  2. **TV Channel Logos:** e.g. Shopping channel logos and pricing displays - especially if they are bright and stationary. Moving or low-contrast graphics are less likely to cause ageing of the screen.
  3. **Time Displays**
  4. **Teletext:** Do not view a stationary page for long periods of time.
  5. **TV Menus**
  6. **Pause Mode:** Do not leave the screen in pause mode for long periods of time, e.g. When watching videos.
- To prevent screen burn if viewing any of the above for long periods of time, reduce contrast and brightness when viewing. Once burn-in occurs it will never disappear completely.

**Earphones**

- Listening to loud sounds for prolonged periods of time may permanently damage your hearing.
- Before putting on earphones, turn the volume down then put the earphones on and slowly increase the volume until you reach a comfortable listening level.

**Standby**

- The  button on the remote control does not switch off the unit completely. The unit will continue to draw electricity from the mains supply while in standby. In the interests of safety and to avoid unnecessary energy consumption, never leave the unit in standby while unattended for long periods of time, e.g. overnight, while on holiday or while out of the house. Switch it off and disconnect the mains plug from the mains socket.

**Batteries**

- Batteries used in the remote control for this unit are easily swallowed by young children and this is dangerous.
- Keep loose batteries away from young children and make sure that the battery holder tray is secure in the remote control. Seek medical advice if you believe a cell has been swallowed.
- Please dispose of batteries correctly by following the guidance in this manual.

**Supervision**

- Children should be supervised to ensure that they do not play with the unit and the remote control.
- Never let anyone especially children push anything into the holes, slots or any other openings in the case - this could result in a fatal electric shock.

**DVD**• **Class 1 Laser Product**

This unit utilises a laser. Use of controls, adjustments or performance of procedures other than those specified herein may result in hazardous radiation exposure.



- Before moving the unit, ensure the disc tray is empty.
- Always remove the disc when the unit is not in use.
- Failure to do so will risk severely damaging the disc and the unit.
- Do not stack devices, heat from other devices may affect the performance of the unit.



The lightning flash with arrowhead symbol, within an equilateral triangle, is intended to alert the user to the presence of uninsulated "dangerous voltage" within the unit's enclosure that may be of sufficient magnitude to constitute a risk of electric shock.



The exclamation point within an equilateral triangle is intended to alert the user to the presence of important operating and maintenance (servicing) instructions in the manual accompanying the unit.

**Service**

- To reduce the risk of electric shock, do not remove screws. The unit does not contain any user-serviceable parts. Please leave all maintenance work to qualified personnel.
- Do not open any fixed covers as this may expose dangerous voltages.

**Maintenance**

- Ensure to unplug the unit from the mains socket before cleaning.
- Do not use any type of abrasive pad or abrasive cleaning solutions as these may damage the unit's surface.
- Do not use liquids to clean the unit.



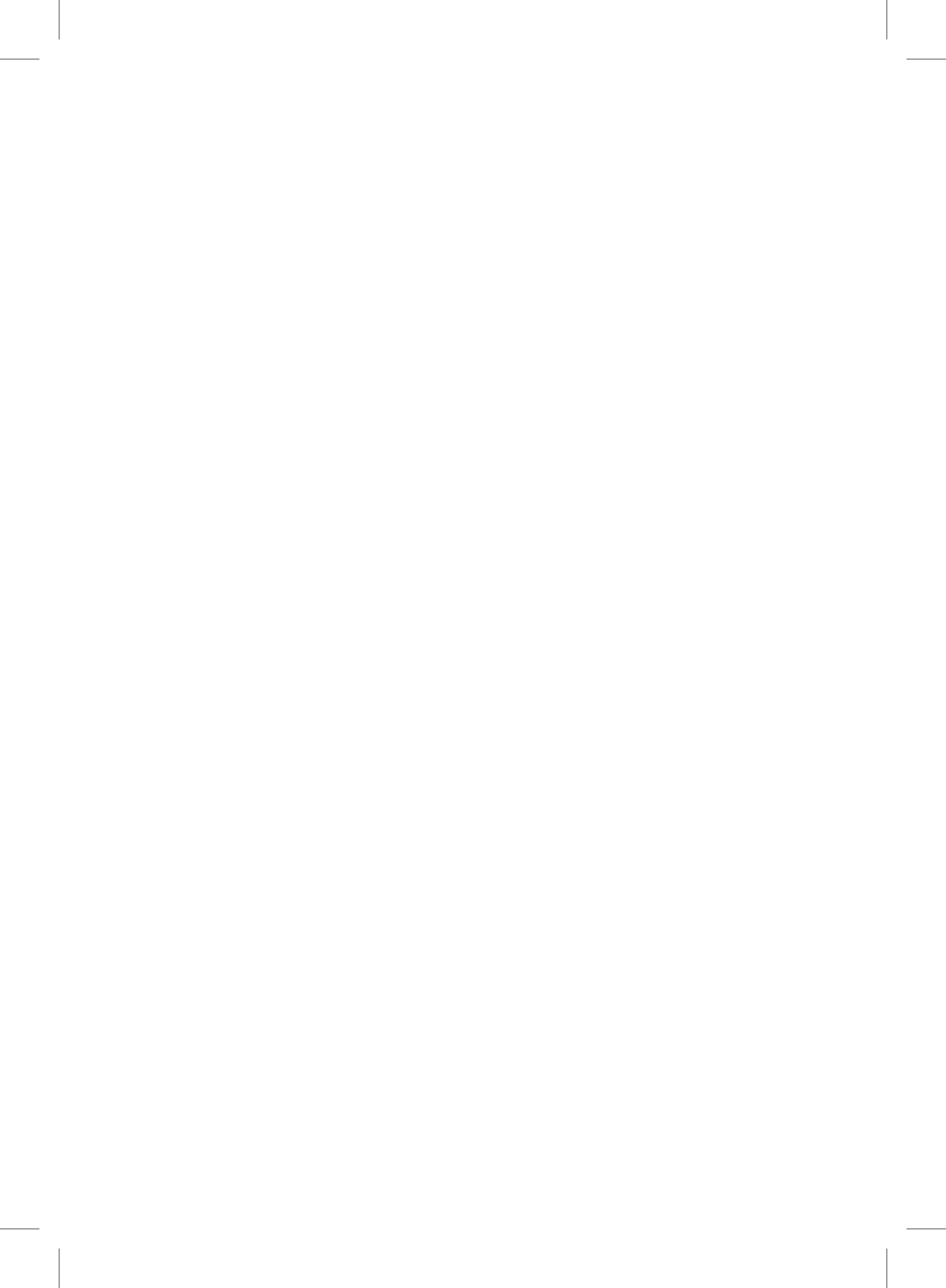





If you require a replacement for any of the items listed below, please quote their corresponding part numbers:

Replacement Part	Part Number
Remote Control	I.14.000000589
Batteries (x2)	E.17.101570001
AV Cable	E.14.113150013
Base Stand	I.01.526302031
Screws x 4	I.03.MP4010001
Instruction Manual	I.08.015229001
Quick Start Guide	I.08.035229002
Digital TV Switchover Addendum	I.08.035197804



Visit [Partmaster.co.uk](http://Partmaster.co.uk) today for the easiest way to buy electrical spares and accessories. With over 1 million spares and accessories available we can deliver direct to your door the very next day. Visit [www.partmaster.co.uk](http://www.partmaster.co.uk) or call 0870 6001 338 (UK customers only) Calls charged at National Rate.



This symbol on the product or in the instructions means that your electrical and electronic equipment should be disposed at the end of its life separately from your household waste. There are separate collection systems for recycling in the EU.

For more information, please contact the local authority or your retailer where you purchased the product.

#### Notes for battery disposal

The batteries used with this product contain chemicals that are harmful to the environment. To preserve our environment, dispose of used batteries according to your local laws or regulations. Do not dispose of batteries with normal household waste.

For more information, please contact the local authority or your retailer where you purchased the product.

HDMI, the HDMI Logo and High-Definition Multimedia Interface are trademarks or registered trademarks of HDMI Licensing LLC.

The FREEVIEW word and logo are trademarks of DTV services Ltd and are used under licence. ©DTV Services Ltd 2002

The "HD Ready" Logo is a trademark of EICTA.

All trademarks are the property of their respective owners and all rights are acknowledged.