

LOGIK

Digital TV SCART Adapter

Instruction Manual
LSSTB11



Content

Unpacking	5
Product Overview	6
Rear View	6
Left View	6
Right View	6
Remote Control	7
Installing Batteries in the Remote Control	9
Using the Remote Control	10
Remote Control Operation Range	10
Connections	11
Connecting to the TV	11
Connecting to External AV Equipment	12
Connecting a USB Storage Device	13
Initial Setting	14
Plug In and Switch On	14
First Time Installation	14
Basic Operation	15
Using the EPG (Electronic Programme Guide)	15
Changing the Channel	16
Changing the Volume	16
Using Subtitles	16
Using Digital Teletext	16
The Info Banner	17

Channel Organiser Menu	18
Delete.....	18
Reorder	18
Rename.....	19
Favourites Menu	20
New.....	20
Edit	20
Reorder	21
Rename.....	21
Delete.....	22
Setup Menu	23
Languages.....	23
TV Setup.....	24
Parental Control.....	25
Service Setup.....	26
Software Update	29
System Information.....	30
Auto Standby Setting	30
Multimedia Menu	32
My Photo.....	32
My Music.....	33
Hints and Tips.....	35
Specification	37
Safety Warnings.....	38

Thank you for purchasing your new Logik Digital TV SCART Adapter.

We recommend that you spend some time reading this instruction manual in order that you fully understand all the operational features it offers. You will also find some hints and tips to help you resolve any issues.

Read all the safety instructions carefully before use and keep this instruction manual for future reference.

Unpacking

Remove all packaging from the unit. Retain the packaging. If you dispose of it please do so according to local regulations.

The following items are included:

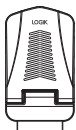

The unit



Remote Control and Batteries

P.N.: 5040F107103



Infrared Receiver & Adhesive Pad

P.N.: 5080F100001



Instruction Manual

P.N.: LSSTB11-IB-002



Quick Start Guide

P.N.: LSSTB11-QSG-002



Mains Adapter

P.N.: 5140F110108



USB Extension Cable

P.N.: 30430101502



If items are missing or damaged, please contact Partmaster (UK only).
Tel: 0844 800 3456 for assistance.

Product Overview

Rear View

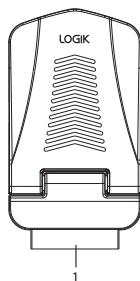

Left View

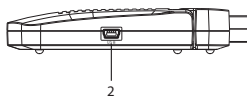

Right View

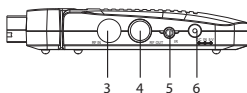

- 1. Scart to TV**
Connects to TV with SCART input.
- 2. Mini USB Socket**
Allows the insertion of a USB storage device with a USB extension cable to playback photo and music files.
Used for upgrading the product's system software purpose.



Do not attempt to service the unit without the appropriate technical support.

- 3. RF IN**
Connects to an aerial.
- 4. RF OUT**
Connects to TV's aerial output socket.
- 5. Remote Sensor**
Receives signals from the remote control.
- 6. DC-IN 5V Connector**
Connects to supplied mains power adapter.

Remote Control

- ⏻ STANDBY Button**
Press to turn the unit to on and standby.
- 🔇 Button**
Press to mute and restore the sound output.
- 0-9 Number Button**
Press to enter values and select the channel directly by entering its number.
- FAV Button**
Press to switch between your favourite channels.
- TV/RADIO Button**
Press to switch between TV and music programmes.
- AUDIO Button**
Press to switch between the audio languages (only applicable when the TV programme has this feature).
- S Button**
Press to set up the available subtitle.
- i Button**
Press to display information about the current programme.
- MENU Button**
Press to display the main menu of the unit.
- GUIDE Button**
Press to display the EPG Electronic Program Guide.
- EXIT Button**
Press to exit the main menu of the unit.

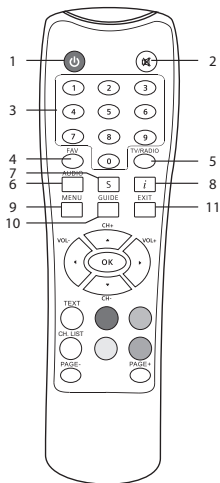

The device will automatically enter into the STANDBY mode if no operation in 3 hours. Press the ⏻ STANDBY button again to turn the power on. The standby reminder will pop up 2 minutes before entering into the STANDBY mode.

12. **CH+ / CH- Button**
Press to select a channel.
- Vol+ / Vol- Button**
Press to adjust the volume.
- ◀▶▶▶ Button**
Allows you to navigate the menus and adjust the system settings to your preference.
- OK Button**
Press to confirm selection in OSD menu.
13. **TEXT Button**
Press to turn on/off teletext/MHEG-5 function.
14. **Colour Buttons (Red/Green/Yellow/Blue)**
The features of these four coloured buttons are defined on different channels, each button will correspond to various coloured page numbers and functions provided by Television broadcasters.
15. **CH. LIST Button**
Press to display the channel list.
16. **PAGE- / PAGE+ Button**
Press to go to the previous / next page in teletext or some menus.

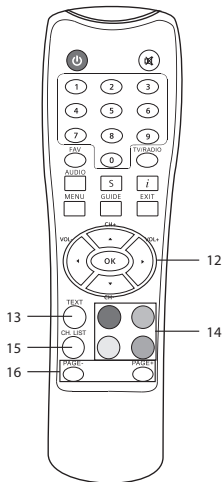

Installing Batteries in the Remote Control

1. Press and lift the battery cover of remote control.
2. Insert 2 x AAA size batteries and make sure to match the (+) and (-) ends of the batteries with the (+) and (-) ends indicated in the battery compartment.
3. Close the battery cover.

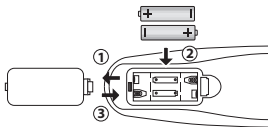

Handling the Batteries

- Improper or incorrect use of batteries may cause corrosion or battery leakage, which could cause fire, personal injury or damage to property.
- Only use the battery type indicated in this manual.
- When the batteries are exhausted, the remote will not function. Replace both batteries at the same time with new ones.
- Do not install new batteries with used ones and do not mix different types of batteries.
- Do not dispose of used batteries as domestic waste. Dispose of them in accordance with local regulations.

Handling the Remote Control

- Take care of your fingernails when you press and hold the battery release tab.
- Do not drop or cause impact to the remote control.
- Do not spill water or any liquid on the remote control.
- Do not place the remote control on a wet object.
- Do not place the remote control under direct sunlight or near sources of excessive heat.
- Remove the battery from the remote control when not in use for a long period of time, as it could cause corrosion or battery leakage and may result in physical injury and/or property damage including fire.

Using the Remote Control

- Be sure to connect supplied infrared receiver prior to using the remote control.
- Remove the self-adhesive seal on the back of the infrared receiver and attach to a clean and flat surface. Locate the receiver in a visible position and point the remote control to the window of front part of the receiver.

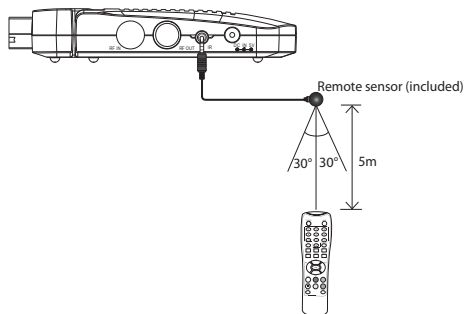

Remote Control Operation Range

Point the remote control unit within approx. 5 metres from the remote control sensor and within 60° in front of the unit. The operating distance may vary depending on the brightness of the room.

Connections

Connecting to the TV

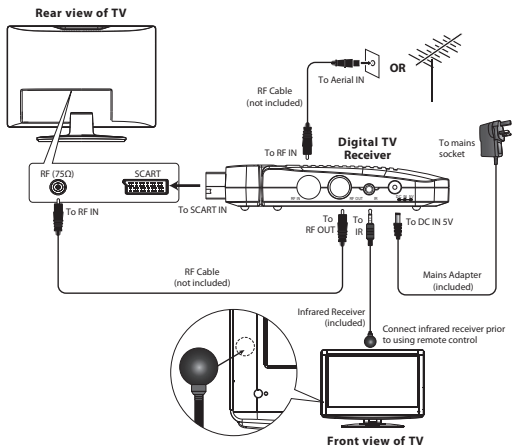

1. Make sure your TV and any other equipment you are connecting to are switched off.
2. Connect one end of the RF coaxial cable (not supplied) to the aerial socket on the wall and the other end of the cable to the RF IN socket of the unit.
3. Connect another RF coaxial cable (not supplied) between the RF OUT socket of the unit and the RF IN socket on your TV.
4. Connect the unit to the SCART IN socket on your TV.
5. Connect the supplied mains adapter (5V DC) to the DC IN 5V socket of the unit and plug in the mains adapter into the mains socket after you have completed all the connections.

Connecting to External AV Equipment

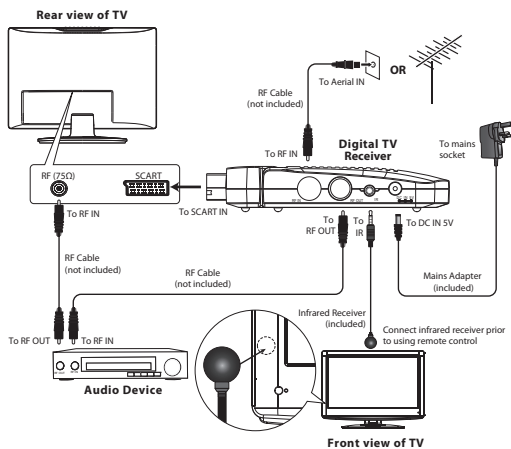

1. Make sure your TV and any other equipment you are connecting to are switched off.
2. Connect one end of the RF coaxial cable (not supplied) to the aerial socket on the wall and the other end of the cable to the RF IN socket of the unit.
3. Connect another RF coaxial cable (not supplied) between the RF OUT socket of the unit and the RF IN socket on your external AV equipment.
4. Connect the RF coaxial cable (not supplied) between the RF OUT socket of your external AV equipment and the RF IN socket on your TV.
5. Connect the unit to the SCART IN socket on your TV.
6. Connect the supplied mains adapter (5V DC) to the DC IN 5V socket of the unit and plug in the mains adapter into the mains socket after you have completed all the connections.

Connecting a USB Storage Device

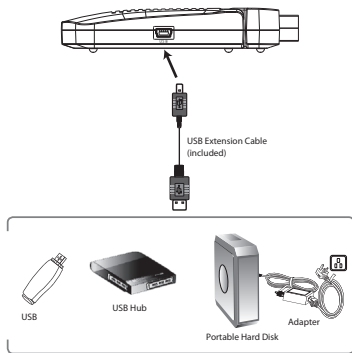

1. Make sure your TV and any other equipment you are connecting to are switched off.
2. Connect your USB storage device to the USB port of your unit with a USB extension cable.
3. Connect the unit to the SCART IN socket on your TV.
4. Connect the supplied mains adapter (5V DC) to the DC IN 5V socket of the unit and plug in the mains adapter into the mains socket after you have completed all the connections.



- The USB connection is not for programme recording, but only for MP3 / JPEG playback. Please refer to the section "Multimedia Menu" for detail.
- Not all the USB devices can be supported by this unit, especially some MP3 players, digital cameras and external hard drive.
- If a hard disk is used, make sure its mains adapter is connected to the mains supply.
- If a USB hub is used, make sure its mains adapter is connected to the mains supply as the total current consumption may exceed 500mA.
- The maximum supported storage space of the hard disk is 1TB.
- Disconnect the USB storage device if it is not in use.

Initial Setting

Plug In and Switch On

Insert the mains adapter to the side of the unit and plug into a mains socket and switch on. The green standby light on the infrared receiver will come on and then go to standby. Press the **STANDBY** button to turn it on. Switch your TV on and select the Scart input.



- Ensure that the aerial is connected to your unit before starting the first time installation.
- Please take some time to perform the first time installation when using the product for the first time.

First Time Installation

1. The first time installation screen will appear on screen. Then press the **OK** button to go to next page.
2. Press the **◀▶** buttons on the remote control to select the aspect ratio you desire to display after scanning the channels. Press the **OK** button. The unit will automatically begin to tune.
3. The scanning progress screen will be displayed, showing you how many channels have been found and saved. The tuning may take several minutes to complete. When the scanning is complete, your unit is ready to use. After scanning is complete, the channels are arranged in a preset order.

Please ensure that the aerial is plugged in your receiver. Then press **OK** to continue.

First Time Installation

Choose the TV type using the **◀▶** keys.
Television type 4:3
Press **OK** to start the installation.

FULL SCAN REPLACE EXISTING SERVICES

Ch	Name	Provider	Type
070	CBBC Channel	CBBC	TV
080	CBBC Real Button	CBBC	TV
085	CBBC NEWS	CBBC	TV
087	CBBC TOPICS	CBBC	TV
092	CBBC TV10	CBBC	TV
091	CBBC One	CBBC	TV

0% 100%

Scanning Please wait

Basic Operation

Using the EPG (Electronic Programme Guide)

1. The Electronic Programme Guide, or EPG, is an on-screen TV guide. It shows all scheduled programmes seven days in advance for every tuned in channel. Press the **GUIDE** button to access the **TV GUIDE** menu.
2. You can press the **▲▼** buttons to select a different channel. Press the **◀▶** buttons to select the programme and then press the **OK** button to watch the programme. Press the **BLUE** button to move to the next day's schedule. It will exit the **TV GUIDE** menu and switch to the TV programme.
3. Press the **GUIDE** button to access the **TV GUIDE** menu again. Press the **BLUE** button to move to the next day's schedule and the **YELLOW** button to move to the previous day.
4. To set a reminder, scroll to a future programme and press the **Green** button. The programme you set will turn green to remind you. The unit will automatically tune to the selected programme when it starts.



- If a reminder has been set your unit will automatically change channel unless you press the **EXIT** button to cancel the reminder.
- Your EPG also contains digital radio channels.

Changing the Channel

Press the **CH+ / -** button to select the channel you want to watch. Alternatively press the **0-9** buttons to key in the channel number.



Press the **CH. LIST** button to enter the channel list and then press the **▲▼** buttons to highlight and select the channel. Press the **OK** button to watch. When you change the channel the info bar will be displayed for a few seconds.

Changing the Volume

You can change the volume of your unit by pressing the **VOL+ / -** buttons. **VOL+** will increase the volume and **VOL-** will decrease the volume.

To turn the volume off, press the **⏸** button on the remote control. To turn it back on, press the **⏸** button again or press the **VOL+ / -** buttons.

Using Subtitles

To use subtitles, press the **S** button on the remote control. The subtitle options will be displayed on screen.



Press the **▲▼** buttons to select an available subtitle language. Press the **OK** button to select it.



Subtitles are only shown when they are broadcast with the programme. Not all programmes have subtitles.

Using Digital Teletext

Many digital channels also provide digital teletext. For example this could be information about programmes, the weather, news and many other topics.

To use digital teletext, press the **TEXT** button on the remote control.



Not all channels have digital teletext.

The Info Banner

1. The info banner can be accessed when you are watching a TV programme, by pressing the *i* button.
2. The info banner gives you the date, and time of the current programme, and also shows you the programme name.
3. Press the **▶** button to see the details of the next programme.
4. If you press the *i* button again you will be shown extended information about the programme.
5. Press the **EXIT** button to close the info banner and return to normal TV viewing.



Channel Organiser Menu

1. Press the **MENU** button to enter the **MAIN MENU**.



2. Press the **▲▼** buttons and then press the **OK** button to select **Channel Organiser**.



The UHF column shows the frequency channel that the service is on. It will only be presented on a terrestrial or cable system.



Delete

- Press the **RED** button to delete channels. The **PIN** window will display on the screen.
- Each time you delete a channel, the **PIN** windows will display on the screen. Press the **0-9** buttons to enter PIN number. The default PIN number is **0000**.

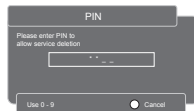

Reorder

1. Press the **CH+ / -** button to select a channel and then press the **GREEN** button to re-order the selected channel.
2. Press the **▲▼** buttons to move the selected channel to a new position and then press the **OK** button to save the new position. Press the **GREEN** button to cancel with no change of position.

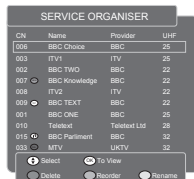

Rename

1. Press the **YELLOW** button to change the favourite list name. The **EDIT** window will display on the screen.
2. Press the **◀▶▶▶** buttons to select characters, and then press the **OK** button to choose a character. Repeat the same setup until the new name is displayed in the text field.



- Press 'CAPS' to toggle the letters between upper-case and lower-case.
- Press 'Delete' to backspace/delete the last character.

3. Press the **GREEN** button to save the new name and exit the menu. Press the **YELLOW** button to cancel the current edit and return to the previous menu with no name change.



Favourites Menu

1. Press the **MENU** button to enter the **MAIN MENU**.



2. Press the **▲▼** buttons and then press the **OK** button to select **Favourites**.



New

Press the **GREEN** button to add a new favourite list.

Edit

- a. Press the **▲▼** buttons to select a favourite list from the **FAVOURITES** window. Press the **YELLOW** button to edit **FAVOURITES**.
- b. Press the **▲▼** buttons to select a channel you wish to add from the left side of the **EDIT FAVOURITES** window. Press the **OK** button to the channel to the favourite list in the right window.

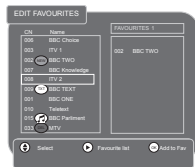

- c. Press the **▶** button to enter to the right window and then press the **▲▼** buttons to select a channel to edit channels if necessary.

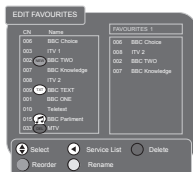

Reorder

- Press the **GREEN** button to reorder favourite channels.
- Press the **▲▼** buttons to move favourite channels, and then press the **OK** button to confirm.
- Press the **GREEN** button again to cancel the operation.

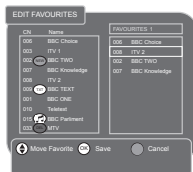

Rename

- Press the **YELLOW** button to change the favourite list name. The EDIT window will display on the screen.
- Press the **◀▶** buttons to select characters, and then press the **OK** button to choose a character. Repeat the same setup until the new name is displayed in the text field.



- Press 'CAPS' to toggle the letters between upper-case and lower-case.
- Press 'Delete' to backspace/delete the last character.

- Press the **GREEN** button to save the new name and return to previous menu. Press the **YELLOW** button to cancel the current edit and return to previous menu with no name change.



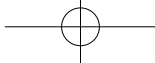

Delete

- Press the **CH+** / - buttons to select a channel from the favourite list.
- Press the **RED** button to delete the selected channel.

To enable your favourites list, select it and then press the **OK** button. To turn favourites off, select **OFF** and press the **OK** button.



When your favourites list is enabled you can only select the channels that have been added to your favourites list.

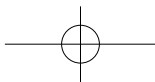
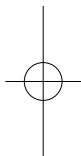
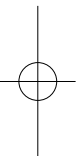

Setup Menu

The setup menu lets you change the default settings of your unit.

Languages

1. Press the **MENU** button to enter the **MAIN MENU**.
2. Press the **▲▼** buttons and then press the **OK** button to select **Setup**.
3. Press the **▲▼** buttons to select **Languages** and then press the **OK** button.
4. Press the **▲▼** buttons to select the desired option and then press the **◀▶** buttons to change the setting. Press the **OK** button to confirm.



Audio	Select the audio channels, which are available in DTV mode.
On Screen Display	Select an available text language to be used in the menus and off-air service information.



- Not all programmes have alternative audio available and English will be used instead.
- The on screen display setting is always set to English and there are not any other options available.

TV Setup

1. Press the **MENU** button to enter the **MAIN MENU**.
2. Press the **▲▼** buttons and then press the **OK** button to select **Setup**.
3. Press the **▲▼** buttons to select **TV Setup** and then press the **OK** button.
4. Press the **▲▼** buttons to select the desired option and then press the **◀▶** buttons to change the setting. Press the **OK** button to confirm.



Television Type	Select the aspect ratio (4:3 / 16:9) that this unit is connected to.
Widescreen	Select what the user requires to be displayed for 16:9 transmissions (Letterbox / Full Frame). Note: This option is only available when 16:9 format content is transmitted under 4:3 Television Type option.
Standard	Set the SCART output mode (CVBS / RGB). Note: Select CVBS to output a standard composite video. Select RGB to output a better picture quality.



If selecting 4:3 you have additional settings available to choose between Letterbox and Full Frame. There will be two blank bars on the top and bottom of the screen if a 16:9 program is broadcast.

5. The standard setting is used to select between RGB and CVBS.



Some older TVs may not support RGB. RGB will give you a better picture quality than CVBS and is the default setting.

Parental Control

1. Press the **MENU** button to enter the **MAIN MENU**.
2. Press the **▲▼** buttons and then press the **OK** button to select **Setup**.
3. Press the **▲▼** buttons to select **Parental Control** and then press the **OK** button.
4. A **PIN** window will display on the screen. Use the **0-9** buttons to enter 4-digit PIN. The default PIN code is **0000**. The Parental Control menu will display on the screen.



The default PIN code is 0000.

Change PIN

1. Press the **▲▼** buttons to select **Change PIN**. The **CHANGE PIN** window will display on the screen.
2. Use the **0-9** buttons to enter numbers in **Enter New PIN** and **Confirm New PIN**. Press the **OK** button to confirm.

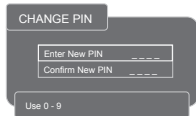
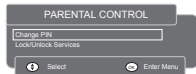

Lock / Unlock Services

1. Press the **▲▼** buttons to select **Lock/Unlock Services** and then press the **OK** button.
2. Press the **CH+ / -** button to select channels and then the **OK** button to lock or unlock channels.



The Lock/Unlock feature is useful for locking channels that have 'Adult' material so that they can't be viewed without entering the PIN code.

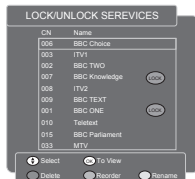

Service Setup

1. Press the **MENU** button to enter the **MAIN MENU**.
2. Press the **▲▼** buttons and then press the **OK** button to select **Setup**.
3. Press the **▲▼** buttons to select **Service Setup** and then press the **OK** button. The **SERVICE SETUP** window will be displayed.



Rescan Channel

1. Press the **▲▼** buttons to select **Rescan Channels** and then press the **OK** button.



- The scanning will be started and replace all the existing services.



- After all available channels have been searched, the unit will enter a TV channel automatically to receive programme.



Manual Scan

- Press the ▲▼ buttons and then press the **OK** button to select the **Manual Scan**.
- Press the ▲▼ buttons to select scan services from **MANUAL SCAN - DIGITAL TERRESTRIAL**.
- Press the ▲▼ buttons to select the desired option and then press the ◀▶ buttons to change the setting.



UHF Channel	Sets the required UHF channel. This will automatically fill in the frequency entry. The options are 21/474000kHz--69/858000kHz.
Frequency	Overrides and sets the frequency in kHz.
Tx Mode	Selects the required transmission mode (2K and 8K).
Guard Interval	Selects the required guard interval (1/4, 1/8, 1/16 and 1/32).
Scan	Select "Started" or "Stopped" to start or stop a service scan.

- Press the **PAGE+** / - button to change the channel in the preview window.

Restore Factory Default

1. Press the ▲▼ buttons and then press the **OK** button to select the **Restore Factory Default**.
2. The Restore Factory Default screen will appear on screen. Press the **OK** button to select YES. Press the **EXIT** button to select No then return to normal TV viewing.
3. After restore factory default setting, the first time installation screen will display on the screen. Press the **OK** button to continue the setup.
4. Select the TV type using the ◀▶ buttons. Press the **OK** button.
5. The tuning progress screen will be displayed, showing you how many channels have been found and saved. Scanning may take several minutes to complete. After all available channels have been searched, the unit will enter a TV channel automatically to receive programme.

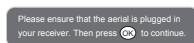
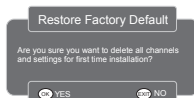

If you are in an area that can receive more than one TV region you will see the region selection screen. Select your preferred region from the list shown and then press the **OK** button. Your unit has now been returned.



Software Update

This function allows you to update the product's system software by USB connection or by OAD setting. OAD (Over the Air Download) means that firmware (a products in-built software) can be sent, installed and updated via a TV broadcast and therefore can be received by your unit via the aerial system.



Do not attempt to service the unit without the appropriate technical support.

1. Press the **MENU** button to enter the **MAIN MENU**.
2. Press the **▲▼** buttons and then press the **OK** button to select **Setup**.
3. Press the **▲▼** buttons and then press the **OK** button to select **Software Update**.
4. The SOFTWARE UPDATE window will display on the screen. Press the **▲▼** buttons to select **Update by USB** or **Update by OAD** and then press the **OK** button to enter.



- Some downloads may be signalled as high priority which means the manufacturer of the product wants the user to perform the download via OAD (Over the Air Download) function provided by the TV broadcast service.
- If a download is not available when manually checking for a download or the download becomes not available, then the following menu will be displayed.



After updated the software on the unit, it will restore factory default mode and the reminder you have set are cancelled.

System Information

1. Press the **MENU** button to enter the **MAIN MENU**.
2. Press the **▲▼** buttons and then press the **OK** button to select **Setup**.
3. Press the **▲▼** buttons to select **System Information** and then press the **OK** button to display the DTV information.



The information shown on your screen may differ to the one shown above.

Auto Standby Setting

1. Press the **MENU** button to enter the **MAIN MENU**.
2. Press the **▲▼** buttons and then press the **OK** button to select **Setup**.



3. Press the ▲▼ buttons to select **Auto Standby Setting** and then press the **OK** button to confirm.



4. Press the ◀▶ buttons to select 3 Hours / 4 Hours / OFF. Press the **OK** button to confirm and then press the **EXIT** button to exit the main menu. The default setting is set to 3 Hours.

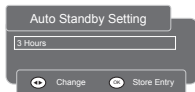

The unit will automatically switch to standby mode 3 hours after the last time the remote control was used. A reminder screen will pop up and count down before the unit switches to standby mode. To turn off the auto standby function, select OFF on the auto standby setting. To save energy you should always turn the auto standby setting back to "3 Hours" or "4 Hours".

Multimedia Menu

The multimedia function is used to playback MP3 and JPEG files via a USB drive.

My Photo

1. Press the **MENU** button to enter the **MAIN MENU**.
2. Press the **▲▼** buttons and then press the **OK** button to select **Multimedia**.



3. Press the **▲▼** buttons to select **My Photo** and then press the **OK** button to confirm.



4. If you have images in the root folder they will load and show on-screen. To navigate around the window press the **◀▶▶▶** buttons.



If your USB drive contains many folders, press the **BLUE** button and then press the **▲▼** buttons to select a folder included photos.



5. Press the *i* button after playback a picture you selected.

Button	Function
RED	Zoom image.
GREEN	Select music file on your USB flash drive.
YELLOW	Flip image horizontally.
BLUE	Flip image vertically.
▲ or ▼	Select next / previous image.
◀ or ▶	Rotate image.
OK	Start slideshow.
EXIT	Close multimedia and exit to live TV broadcasting.

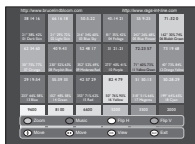

6. After slide show, press the *i* button to select the below features.

Button	Function
RED	Play / Pause in slide show mode.
GREEN	Select music file on your USB flash drive.
YELLOW	Select repeat Once / All.
BLUE	Select Fast / Middle / Slow for the speed of slide show.
▲ or ▼	Select next / previous image.
MENU	Back to the Thumbnail.



My Music

- Press the **MENU** button to enter the **MAIN MENU**.
- Press the **▲▼** buttons and then press the **OK** button to select **Multimedia**.



- Press the ▲▼ buttons to select **My Music** and then press the **OK** button to confirm.
- If you have MP3 files in the root folder they will load and show on-screen in the right hand column.
- Press the ▲▼ buttons to select an MP3 file and then press the **OK** button to confirm the selected MP3 music file. Or press left button then press the ◀ button and then press the ▲▼ button to select a different folder in the left hand column. After selecting the folder, press the ▶ button to the right hand column. Press the ▲▼ buttons to select the music at this folder.



- Supported file: mp3.
- The "Unsupport Format" will show when selected the unupport file format.

Button	Function
RED	Play/Pause the MP3.
GREEN	Fully stop playback of the MP3
YELLOW	Change the repeat mode between Repeat Off, Repeat All, or Repeat One.
BLUE	Increase the playback speed of the MP3. (▶▶ x 1, ▶▶▶ x 2, ▶▶▶▶ x 3, then return normal playback)
<i>i</i>	See the available and used space on your USB flash drive.
▲ or ▼	Move up and down the column.
◀ or ▶	Swap between left and right columns.
OK	Select to confirm.
EXIT	Close multimedia and exit to live TV.

Hints and Tips

If a problem does occur, it may often be due to something very minor. The following table contains various tips.

Problem	Solution
No power	<ul style="list-style-type: none">• Check to make sure the mains adapter is plugged into the mains outlet.• Make sure there is power to the mains socket.
No pictures	<ul style="list-style-type: none">• Check the aerial connection is connected properly.• Check the connections between the unit and external equipment.• Check the power of external equipment is turned on.• Switch to another channels. If their signals are fine, it is likely that the problem is from the TV station.
Unclear or unstable picture	<ul style="list-style-type: none">• Check that the aerial is connected.• Adjust or move your aerial to a different location.• Adjust from Menu setting to select the correct TV system settings.
No sound or noisy sound	<ul style="list-style-type: none">• Check the connection of the aerial.• Check that the aerial is not broken.• Press the VOL+ / - button or mute on the remote control.
Remote control	<ul style="list-style-type: none">• Make sure there are no obstructions between the remote control and the unit.• Replace the remote control batteries if the remote control has lost power.• Check that the batteries are installed with the correct polarities (+ and -).• Remove any obstacles between the remote control unit and the remote control signal sensor.

Problem	Solution
DTV interference	<ul style="list-style-type: none"> • The reception becomes weak under rainy or cloudy weather. • The effect of the intervening terrain (e.g. mountains and valleys) can weaken the quality of signals. • Place the unit in a flat and open area to get good signal reception. • Placing the unit nearby tall buildings will cause poor signal reception. • Placing the unit near the window can improve the signal reception quality.
If the picture on TV set is only colour bar via SCART cable	<ul style="list-style-type: none"> • Select a proper SCART output (RGB or CVBS) from the TV setup menu in the main menu.
The unit does not work properly	<ul style="list-style-type: none"> • Please restart the unit.
Lost Password	<ul style="list-style-type: none"> • Select the Parental Control setting in the Setup Menu, then enter the following master password "1307". The master password clears your previous password and allows you to enter a new password.

Specification

Tuner and channel	<ul style="list-style-type: none">RF input connector (IEC-TYPE, IEC169-2, female)RF output connector (IEC-TYPE, IEC169-2, male)
Decoder <ul style="list-style-type: none">Transport streamProfile levelInput rateVideo formatAudio formatVideo output	MPEG-2 ISO/IEC 13818 MAX. 15Mbit/s MPEG-2 Main profile @main level 4:3/16:9 Switchable MPEG Layer I & II, 32 / 44.1 / 48KHz RGB, CVBS
Connection <ul style="list-style-type: none">PowerTunerVideo	5V Mains adapter RF input / RF output TV SCART
Power supply <ul style="list-style-type: none">Input voltagePower consumption	AC 100-240V ~50/60Hz (Mains Adapter) MAX. 6W (5V; 1.25A)
Dimension	168 x 80 x 28mm
Weight	80g

Features and specifications are subject to change without notice.

Safety Warnings

Read all the instructions carefully before using the unit and keep them for future reference.

Retain the manual. If you pass the unit onto a third party make sure to include this manual.

Check that the voltage marked on the rating label matches your adapter voltage.

Damage

Please inspect the unit for damage after unpacking.

Do not continue to operate the unit if you are in any doubt about it working normally, or if it is damaged in any way - switch off, withdraw the mains adapter and consult your dealer.

Location of Unit

The unit must be placed on a flat stable surface and should not be subjected to vibrations.

Do not place the unit on sloped or unstable surfaces as the unit may fall off or tip over.

The mains socket must be located near the unit and should be easily accessible. This unit is designed for indoor use only.

Temperature

Avoid extreme degrees of temperature, either hot or cold. Place the unit well away from heat sources such as radiators or gas/electric fires.

Avoid exposure to direct sunlight and other sources of heat.

Naked Flames

Never place any type of candle or naked flame on the top of or near the unit.

Moisture

To reduce the risk of fire, electric shock or product damage, do not expose this unit to rain, moisture, dripping or splashing. No objects filled with liquids, such as vases, should be placed on the unit.

If you spill any liquid into the unit, it can cause serious damage. Switch it off at the mains immediately. Withdraw the mains adapter and consult your dealer.

Ventilation

To prevent the risk of electric shock or fire hazard due to overheating, ensure that curtains and other materials do not obstruct the ventilation vents.

Do not install or place this unit in a bookcase, built-in cabinet or in another confined space. Ensure the unit is well ventilated.

Safety

Always disconnect the unit from the mains supply before connecting/disconnecting other devices or moving the unit.

Unplug the unit from the mains socket during a lightning storm.

Mains Adapter Cable

Make sure the unit or unit stand is not resting on top of the mains cable, as the weight of the unit may damage the mains cable and create a safety hazard. If the mains cable is damaged it must be replaced by the manufacturer, its service agent, or similarly qualified persons in order to avoid a hazard.

Interference

Do not place the unit on or near appliances which may cause electromagnetic interference. If you do, it may adversely affect the operating performance of the unit, and cause a distorted picture or sound.

Standby

The  button on the remote control does not switch off the unit completely. The unit will continue to draw electricity from the mains supply while in standby. In the interests of safety and to avoid unnecessary energy consumption, never leave the unit in standby while unattended for long periods of time, e.g. overnight, while on holiday or while out of the house. Switch it off and disconnect the mains adapter from the mains socket.

Batteries

Batteries used in the remote control for this unit are easily swallowed by young children and this is dangerous.

Keep loose batteries away from young children and make sure that the battery holder tray is secure in the remote control. Seek medical advice if you believe a cell has been swallowed.

Please dispose of batteries correctly by following the guidance in this manual.

Supervision

Children should be supervised to ensure that they do not play with the unit and the remote control.

Never let anyone especially children push anything into the holes, slots or any other openings in the case - this could result in a fatal electric shock.



The lightning flash with arrowhead symbol, within an equilateral triangle, is intended to alert the user to the presence of uninsulated "dangerous voltage" within the unit's enclosure that may be of sufficient magnitude to constitute a risk of electric shock.



The exclamation point within an equilateral triangle is intended to alert the user to the presence of important operating and maintenance (servicing) instructions in the manual accompanying the unit.

Service

To reduce the risk of electric shock, do not remove screws. The unit does not contain any user-serviceable parts. Please leave all maintenance work to qualified personnel.

Do not open any fixed covers as this may expose dangerous voltages.

Maintenance

Ensure to unplug the unit from the mains socket before cleaning.

Do not use any type of abrasive pad or abrasive cleaning solutions as these may damage the unit's surface.

Do not use liquids to clean the unit.

get set for digital

How the digital switchover may affect you:

Television in the UK is going digital, bringing us all more choice and new services. Starting in late 2007 and ending in 2012, television services in the UK will go completely digital, TV region by TV region.

The map shows when your area will switchover to digital. When the TV switchover happens in your area, there are at least two occasions when you will need to re-tune your unit in order to continue receiving your existing TV channels, and also to pick up new ones.

Digital UK, the body leading the digital TV switchover, will advise you when you need to re-tune during the switchover.

For re-tuning instructions for this unit please see page 26-27 of this instruction manual.

If you find you can't receive the extra digital channels, it may be because your area is not covered by Freeview yet or that you need an aerial upgrade. Visit www.digitaluk.co.uk to check.

If you have any questions, please contact your equipment supplier or call Digital UK on 0845 6 50 50 50 or visit www.digitaluk.co.uk.

When does switchover happen?

*Capped switchover on October 12, 2007

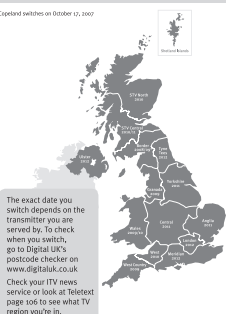

The exact date you switch depends on the transmitter you are served by. To check when you switch, go to Digital UK's postcode checker on www.digitaluk.co.uk

Check your ITV news service or look at teletext page 606 to see what TV region you're in.

Visit us at digitaluk.co.uk call us on 0845 6 50 50 50*

NOTE: If you require a replacement for any of the items listed below, please quote their corresponding part numbers:

Replacement Part	Part Number
Remote Control	5040F107103
Infrared Receiver	5080F100001
Mains Adapter	5140F110108
USB Extension Cable	30430101502



Visit Partmaster.co.uk today for the easiest way to buy electrical spares and accessories. With over 1 million spares and accessories available we can deliver direct to your door the very next day. Visit www.partmaster.co.uk or call 0844 800 3456 (UK customers only) Calls charged at National Rate.

Notes for battery disposal

The batteries used with this product contain chemicals that are harmful to the environment. To preserve our environment, dispose of used batteries according to your local laws or regulations. Do not dispose of batteries with normal household waste.

For more information, please contact the local authority or your retailer where you purchased the product.



This symbol on the product or in the instructions means that your electrical and electronic equipment should be disposed at the end of its life separately from your household waste. There are separate collection systems for recycling in the EU.

For more information, please contact the local authority or your retailer where you purchased the product.

The FREEVIEW word and logo are trademarks of DTV services Ltd and are used under licence. ©DTV Services Ltd 2002

All trademarks are the property of their respective owners and all rights are acknowledged.

DSG Retail Ltd • Maylands Avenue • Hemel Hempstead
Herts • HP2 7TG • England

(P.N.: LSSTB11-IB-002)

