

Sandstrøm

Instruction Manual

Microwave / Combination Oven

S20MB10





Table of Contents

Your new Sandstrøm Microwave	4	Before Use
Safety Information	4 - 8	
Using Aluminium Foil in your Microwave	9	
Unpacking and Getting Ready	10	
Introducing Microwave Cooking	11 - 15	
• Cooking with a Microwave	11	
• Microwave Heating Categories	12	
• Steam	13	
- Condensation	13	
• Product Overview	13 - 14	
- Control Panel Overview	14	
- Accessories	14	
• Checking your Microwave	15	
<hr/>		
Clock Setting	16	Operating Instructions
Setting the Child Lock	17	
Microwave Cooking	18	
Two-Stage Cooking	19	
Delay Start Cooking (Programme Set in Advance)	20	
Auto Cooking	21 - 22	
Quick Start Cooking	23	
Defrosting	24	
• Defrost by Weight	24	
• Defrost by Time	24	
Querying the Cooking Function	25	
<hr/>		
Cleaning your Microwave	26 - 27	Care, Maintenance and Troubleshooting
Frequently Asked Questions	28 - 29	
• Questions and Answers	28 - 29	
Specification	30	

Your new Sandstrøm Microwave

Congratulations on the purchase of your new Sandstrøm Microwave. These operating instructions will help you use it properly and safely.

Before using your Sandstrøm Microwave

- Read these instructions carefully and retain for future reference.
- Remove all packaging labels. Please dispose of them properly.

Before calling for service

- Review the section on Troubleshooting. This will help you to solve some general problems by yourself and reduce the need to ask for the help of professional technicians.

Safety Information

General Safety

- Switch off and unplug before fitting or removing tools/attachments, after use and before cleaning.
- Keep your fingers away from moving parts and fitted attachments.
- Never use a damaged machine.
- Never operate the machine when it is empty.
- Keep mains cable out of reach from children.
- Keep power unit, mains cable or plug away from water.
- Never exceed the maximum capacities.
- When using an attachment, read the accompanying safety instructions.
- Take care when lifting this appliance as it is heavy.
- You should always have your microwave checked by a qualified technician if it has been dropped or damaged to ensure it is safe to use.
- This appliance is not intended for use by persons (including children) with reduced physical, sensory or mental capabilities, or lack of experience and knowledge, unless they have been given supervision or instruction concerning use of the appliance by a person responsible for their safety.
- Children should be supervised to ensure that they do not play with the appliance.
- Only use the appliance for its intended domestic use. We will not accept any liability if the appliance is subject to improper use, or failure to comply with these instructions.

Safety Information

Maintenance of your microwave

WARNING : It is hazardous for anyone other than a qualified technician to carry out any service or repair operation which involves the removal of a cover that gives protection against exposure to microwave energy.

WARNING : If the door or door seals are damaged, the microwave must not be operated until it has been repaired by a qualified technician.

- If smoke is observed, switch off or unplug the appliance and keep the door closed in order to contain any flames.
- If the mains cable is damaged, it must be replaced by a service agent or a qualified technician.
- If you have a pacemaker, please contact your doctor before using a microwave.

Microwave use

- This microwave is not intended for commercial use.
- It should never be used for drying clothes or for other non-food purposes.
- The microwave should not be left unattended when in use.
- The temperature of accessible surfaces may be high when the appliance is operating.
- To prevent high moisture content gathering inside the microwave cavity, open the door immediately after the cooking function has stopped to allow steam to escape.
- Only use utensils that are suitable for microwave use.
- Care should be taken when using paper, plastic, wooden or other combustible materials in the microwave as they can catch fire.
- Oil & fat for deep frying should not be heated in the microwave.
- Only use cling film designed for microwave use and take extra care when removing the film to avoid steam burns.
- Only heat popcorn that has been designed for microwave use.

Safety Information

Cooking Use

As the power of different microwave ovens can vary considerably, care must be taken when first using this appliance as it may cook faster than expected.

- Do not leave the appliance unattended during use.
- Take care when cooking food with a high sugar or fat content, such as Christmas pudding or fruitcake. The sugar or fat can overheat and in some cases catch fire.

Fire!

In the event of fire:

- Keep the microwave door closed.
- Turn off the power.
- Unplug the appliance from the mains power.

First Aid

Treat scalding by:

- Quickly placing the scald under cold running water for at least 10 minutes.
- Cover with a clean dry dressing. Do not use creams, oils or lotions.

Cleaning your Microwave

The microwave should be cleaned regularly and food deposits removed. Failure to maintain the microwave in a clean condition can affect the life of the appliance and possibly result in a hazardous situation. (See cleaning your microwave)

Safety Information

Do not use these in your Microwave

- Metal objects are not to be used in the microwave. This include:
 - Metal cooking utensils.
 - Metal plates or trays
 - Wine twist ties
 - Crockery with metal trims
 - Meat thermometer
- Never use equipment made of metal, except foil in your microwave. The microwave energy cannot pass through the metal so it bounces off and sparks against the inside of the microwave.
- Stop the microwave straight away if any equipment is causing sparks.
- Remember that some crockery has a metal trim around the edge. Even this trim can cause sparks.

Checking your Cooking Utensils

Most heat-resistant, non-metallic cooking utensils are safe to use in your microwave. If you are not sure if you can use a utensil in your microwave, follow this simple test:

1. Put the utensil into the microwave next to a cup of water – use a cup that you know is microwave safe. Close the door.
2. Turn the microwave on for 30 seconds only.
3. After 30 seconds, carefully check to see if the water has warmed up.
4. If the water has not warmed up but the utensil has, the utensil is not microwave safe and should not be used in the microwave.
5. Do not use your hands to touch the utensils as it may already be hot.

Containers

WARNING  : Pressure will build up in sealed containers and can cause them to explode.

Therefore, do not use the following in your microwave:

- Sealed containers
 - Capped bottles
 - Vacuum containers
 - Sealed jars
 - Hard-boiled eggs
 - Eggs in their shells
 - Nuts
- Always pierce the skin of fruit and vegetables, such as potatoes.
 - Never use scratched, cracked or damaged glass in a microwave. Damaged glass can explode.

Safety Information

Delayed Boiling

Liquids heated in a microwave can boil up when removing them from the microwave.

Take the following precautions :

- Always stir liquids, before and after cooking.
- Allow them to stand.
- Use containers that are wider at the top than at the bottom.

Preparing food for Babies

Extra care must be taken when preparing food or drink for babies and small children.

- Always test the food or liquid temperature before feeding it to the baby.
- When using a baby bottle, ensure the teat is removed before heating.
- When warming milk, ensure the bottle is shaken.

Caution!

During cooking the outer surface will become hot. Do not touch the outer casing of the microwave. Care should be taken not to store any items on top of your microwave.



Earthing Instructions

WARNING: THIS APPLIANCE MUST BE EARTHED.

- This appliance is equipped with a mains cable having an earthed plug.
- The plug must be plugged into an appropriate outlet that is installed and earthed in accordance with all local standard and requirements.

Warning!

- Improper connection of the appliance-earthing conductor can result in a risk of an electric shock.
- Check with a qualified electrician or service representative if you are in doubt whether the appliance is properly earthed.
- Never modify the plug provided with the appliance.
- If the plug does not fit properly in the mains socket, have a qualified electrician to install a proper mains socket.

Using Aluminium Foil in your Microwave

It is safe to use aluminium foil in your microwave as long as you follow these safety guidelines.

As with all metal, microwave energy cannot pass through foil, but provided that you keep the foil away from the side of the microwave it will not cause sparks and there will not be any damage to your microwave.

Using foil is a good way of shielding parts of food that you do not want to cook as quickly as others – perhaps where the food is narrower and would otherwise overcook.

Place the foil over the area you want to shield, taking care that the foil will not touch the sides of the microwave when the turntable rotates. Only use one piece of foil at a time so that you do not get sparks between the separate pieces.

Follow these guidelines when using foil in your microwave:

- Remove foil lids from containers before using in the microwave. Some lids are made of card with a foil covering – these should be removed too. Use a microwave safe transparent lid if possible.
- Stir food during cooking if the container has a lid or film cover.
- Always use the glass turntable.
- Use shallow containers with a large surface area. Do not use containers that are more than 1.25in (3.5cm) deep.
- Use gloves when handling hot foil containers.
- Do not completely cover food with foil. The microwave energy cannot pass through the foil so the food will not cook.
- Do not let aluminium foil touch the inside of the microwave.
- Do not use more than one piece of foil in the microwave at the same time.

Unpacking and Getting Ready

This microwave is designed for home use. It should not be used for commercial catering.

1. After unpacking your microwave, check that it has not been damaged whilst in the box. Make sure there are no dents on the oven, and the door closes properly. A dented or damaged oven could allow microwave energy to escape. Make sure that you have taken all the packaging from inside the microwave. Please dispose of the plastic wrappings or bags safely and keep out of the reach of babies and young children.

2. Choose a flat work surface for your microwave away from heat sources such as radiators or fires and away from cold areas. You should allow a 10cm space all around the oven and 30cm above so that warm air can escape from the vents during cooking – This microwave is not designed to be built in. (See Fig. 1)

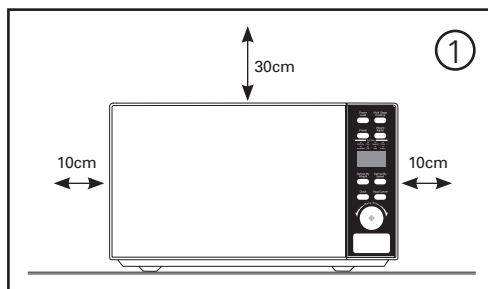

3. Plug your microwave into a standard household electrical socket (230-240 volt, 13 amp rated). Avoid using a socket that also has an adaptor and other equipment plugged in. Do not use a multi-adaptor.

4. Put the turntable ring inside the microwave and place the glass turntable on top of the ring. (See Fig. 2) The turntable is shaped to sit securely on the spindle. You must always use the turntable and ring whenever you use the microwave.

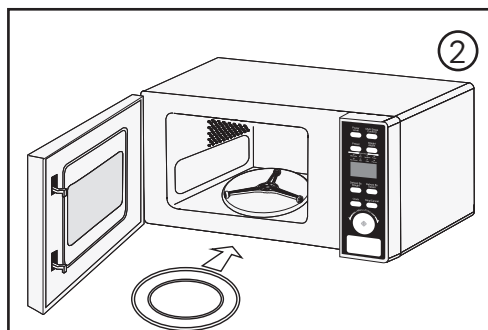

5. To protect your work surface, we recommend that you fix some non-slip cushion pads (not included) to the underside of the microwave. (See Fig. 3)

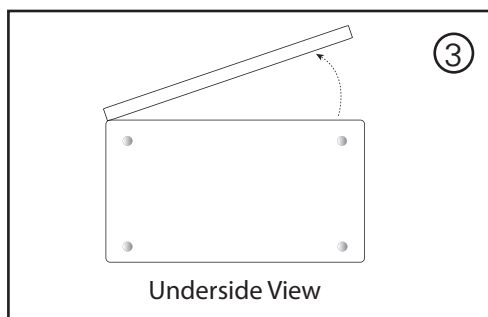



Introducing Microwave Cooking

Always remember the basic safeguards you should follow when using any cooking equipment or handling hot food.

See below for basic guidelines in microwave cooking.

Cooking with a Microwave

- Cooking with a microwave is much faster than conventional cooking and, whilst you should make sure that food is fully cooked, you should be careful not to overcook it.
- Microwave energy can heat unevenly so stirring to distribute heat is very important. Always stir from the outside, inwards.
- If you are cooking a number of individual foods at the same time, such as baked potatoes or small cakes, arrange them evenly on the turntable so that they cook evenly. Never stack food in your microwave.
- Turn larger foods such as meat roasts and poultry during cooking so that the top and bottom cook evenly. It is also recommended to turn pieces of meat or poultry, especially if they have not been deboned.
- Meat and poultry which is cooked for 15 minutes or more will brown lightly in it's own fat. Anything cooked for a shorter time can be brushed with a browning sauce to give an appetising colour.
- Strips of aluminium foil can be used to cover the thinner pieces of food to stop them overcooking before the thicker parts of the food have had a chance to cook. Use the foil sparingly and wrap around the food or container carefully to stop it touching the inside of the microwave which could cause sparks.

- Microwave ovens cook food using microwave energy that is similar to naturally occurring radio waves. Normally, these "waves" would fade as they dispersed into the atmosphere but in a microwave they are concentrated onto the food causing it to heat up.
- Microwave energy cannot pass through metal – so it cannot escape from inside your microwave – but it can pass through materials like glass, porcelain, plastic and paper. These materials are used in the manufacture of microwave safe cooking equipment.
- Microwave safe cooking equipment will still get hot as the food it contains heats up.

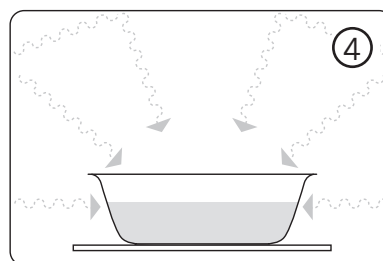

The microwave energy focuses on the moisture in the food causing lots of tiny vibrations. The vibrations get so great that the moisture – and the food – heat up. (See Fig. 4)



Microwave Heating Categories

Your microwave has been tested and labelled to meet the government's voluntary agreement on the reheating of pre-cooked food.

The heating characteristics and output power levels of microwave ovens are usually calculated using a relatively large portion of food (a 1000 gram load, IEC 705) but many packs of pre-cooked food are sold in smaller packs, often about 350 grams. The government, in partnership with food companies and microwave manufacturers, have set up a system of heating categories to help you choose the reheating time for pre-cooked food.





800W is the output power of the microwave oven.

E is the heating category for your microwave oven. Check the cooking times for category E on the food's packaging to see how long it should be cooked for. Please see below example for reference.

To Microwave:
 Remove outer packaging.
 Pierce film lid SEVERAL TIMES.
 Place on a microwaveable plate.
 Heat on full power.
 Stir or turn halfway through heating.

To Microwave from frozen:
 Remove outer packaging.
 Pierce film lid SEVERAL TIMES.
 Place on a microwaveable plate.
 Heat on full power.
 Stir or turn halfway through heating.

	Heating Category		Wattage (IEC 705)	
	B	D	650W	750W
	B	D	650W	750W
Full power (in minutes)	2	2	2	2
Stir / Turn	Stir / Turn		Stir / Turn	
Full power (in minutes)	2	1.5	2	1.5
Standing time (in minutes)	1	1	1	1

	Heating Category		Wattage (IEC 705)	
	B	D	650W	750W
	B	D	650W	750W
Full power (in minutes)	3	2.5	3	2.5
Stir / Turn	Stir / Turn		Stir / Turn	
Full power (in minutes)	4	3.5	4	3.5
Standing time (in minutes)	1	1	1	1

Steam

When you microwave food, steam is created as water in the food heats up and evaporates.

The steam formed during microwave cooking is entirely safe. It has to escape from the microwave to prevent pressure from building up inside the oven. It does this through the vents on the back of the microwave and from around the door.

Condensation

As the steam cools, you may find the condensation gathers in small pools inside your microwave and on the work surface beneath the door and vents. Always dry the microwave after cooking foods with a high moisture content.

Your microwave is designed to let steam escape from the vents and around the door without microwave energy escaping. (See Fig 5) There is no danger of microwave energy escaping with the steam.

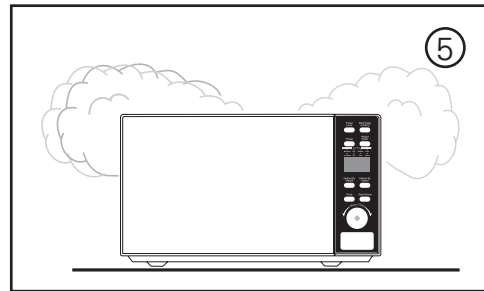

Before Use

Product Overview

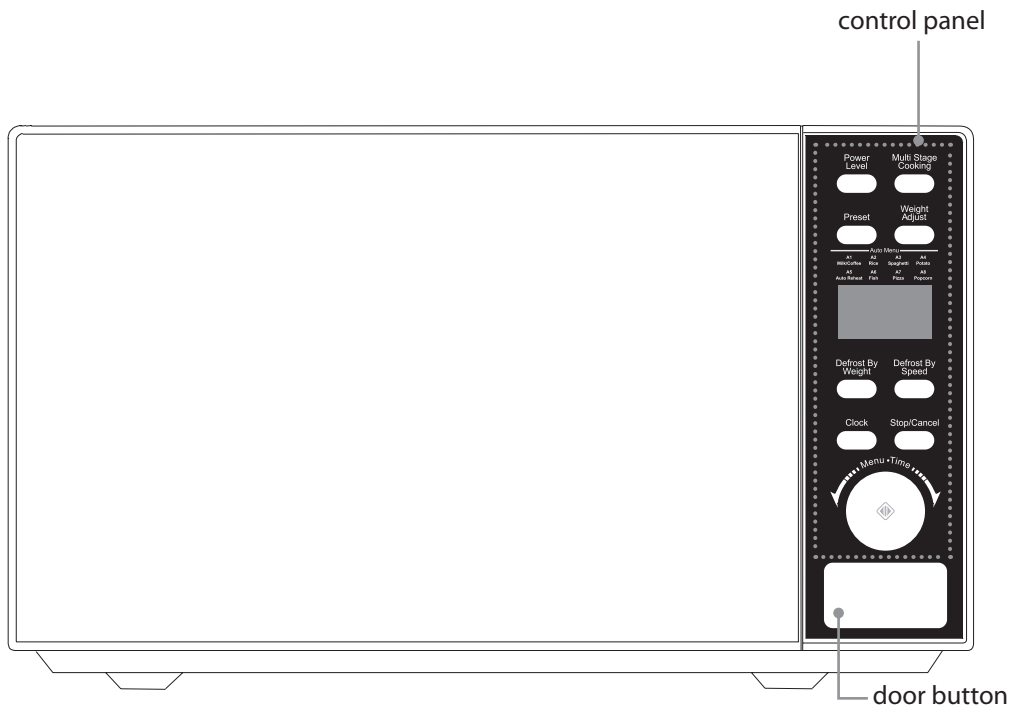

GB-13

Control Panel Overview

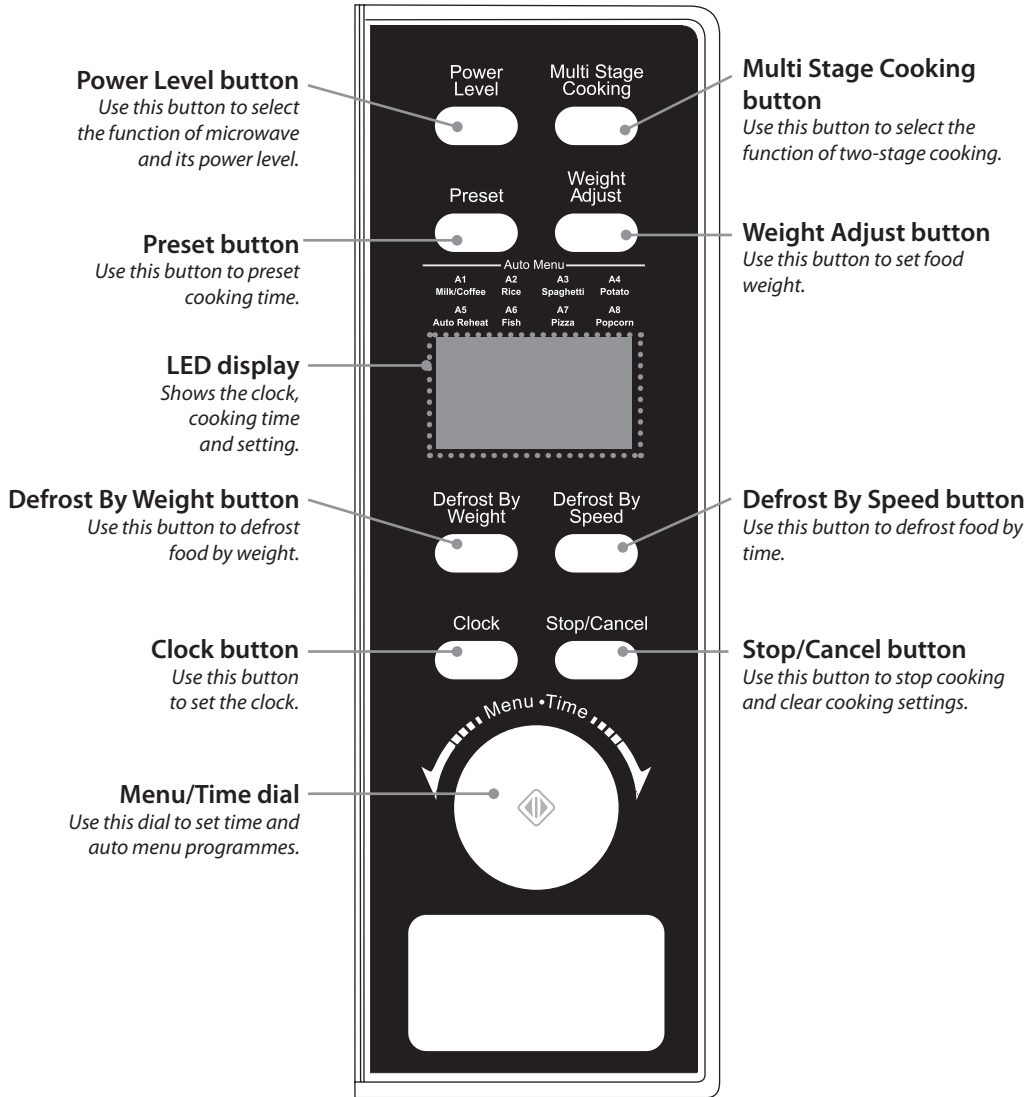

Accessories

Part Numbers XGALS20MB10P12

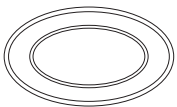

Glass Turntable
x 1

Part Number XGALS20MB10P11



Turntable Ring
x 1

Part Number XGALS20MB10B04



Instruction Manual
x 1

Checking your Microwave

Check your microwave after unpacking.

NOTE: For your safety, the microwave stops if the oven door is opened during cooking. Close the door and press the  (**Menu/Time** dial) to continue the cooking cycle.

1. Push the button to open the oven door. Put the turntable ring inside the oven and place the glass turntable on top of the ring. The inner ring of the turntable is shaped to sit securely on the spindle. (Fig 1)
You must always use the glass turntable and turntable ring whenever you use the microwave.
Place a cup of water on the glass turntable. Make sure the cup is microwave safe - it should not have any decorative metal trim.
2. Close the oven door.
3. Press the **Stop/Cancel** button to clear any settings that have already been made. (See Fig 6)
4. Press the  (**Menu/Time** dial) once to start a simple 30-second microwave cooking cycle and that allows you to check the operation of the microwave oven.
5. When the cooking cycle has finished, the water should be hot (be careful when you take the cup out of the microwave). Press the **Stop/Cancel** button to clear any settings.

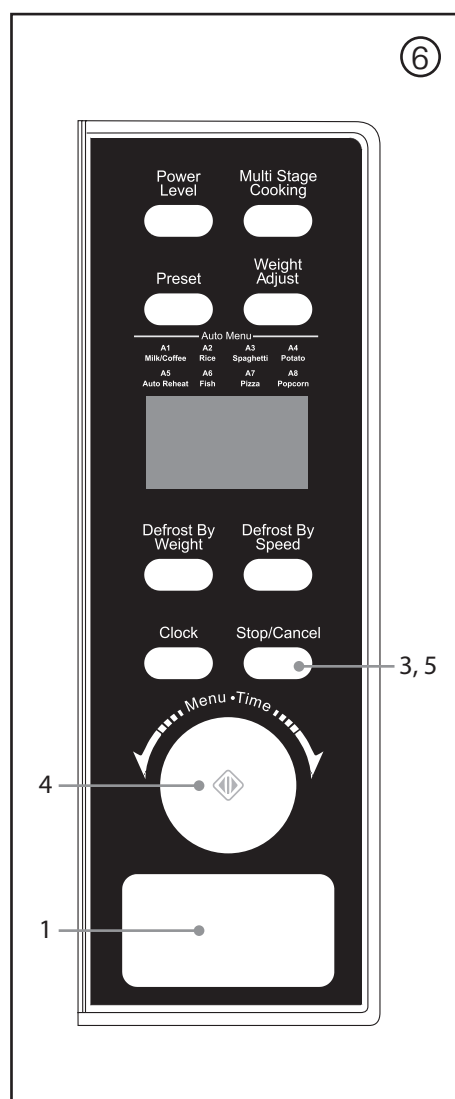

Clock Setting

When the microwave is connected to the mains power, the LED display will show ☉ and 1:00, and it will sound once. Please ensure you have set the clock prior to use.

Please follow the steps below to set the clock.

1. Press the **Clock** and the hour figures will flash.
2. Turn the **Menu/Time** dial to adjust the hour figures. The input time has to be within 00-23.
3. Press the **Clock** and the minute figures will flash.
4. Turn the **Menu/Time** dial to adjust the minute figures, the input time has to be within 00-59.
5. Press the **Clock** again to complete the clock setting. The time will illuminate.

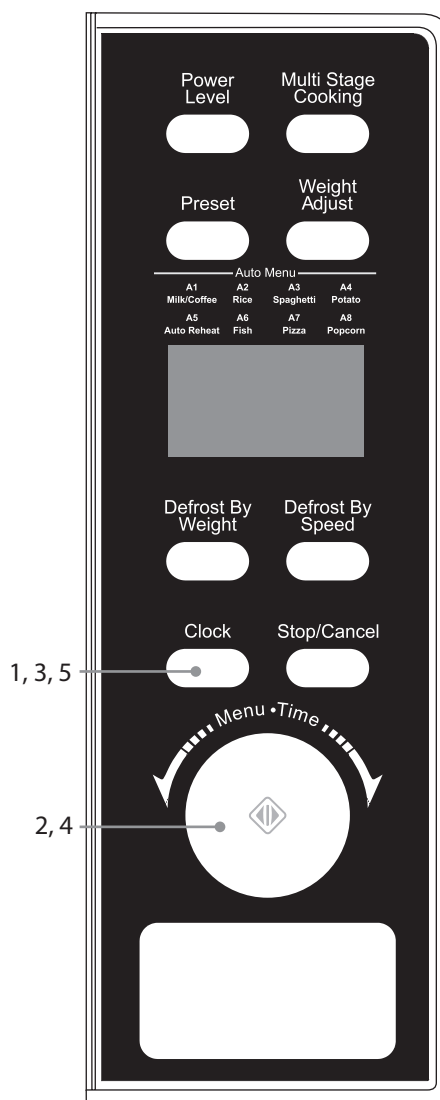

Setting the Child Lock

This feature prevents the electronic operation of the microwave by locking the operation of the control panel until you have cancelled it.

Please follow the steps below to set the child lock.

1. Press the **Stop/Cancel** button for 3 seconds and a long tone will sound. The LED display will also show  to indicate the microwave has set the child lock.
2. To release the child lock, press the **Stop/Cancel** button again for 3 seconds and a long tone will sound to indicate that the microwave has released the child lock.

NOTE: The child lock function cannot be set under delay start cooking.

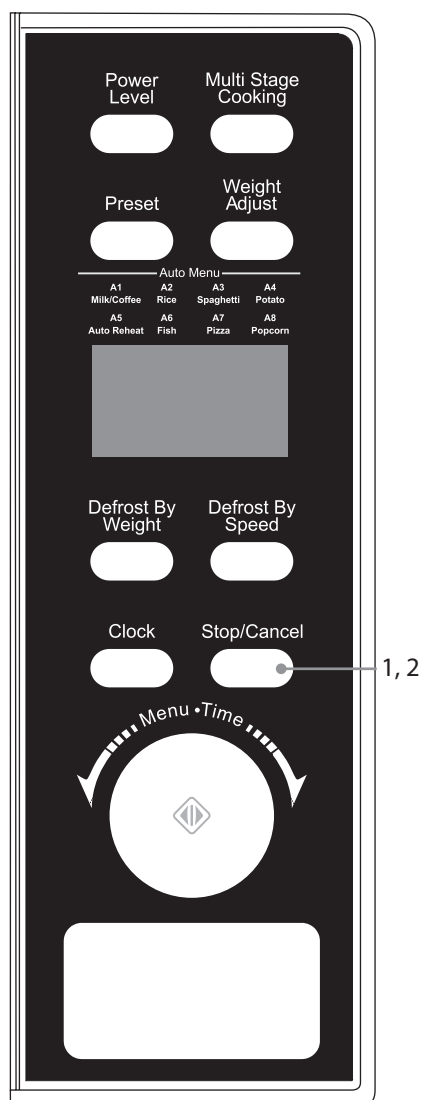





Before Use



Microwave Cooking







For simple **Microwave Cooking**, follow the steps below.

For instance: If you want to use 80% microwave power to cook for 20 minutes.

1. Press the **Power Level** button once and the LED display will show 100%, , 1S, . Press the button again to change the microwave power level to 80%, , 1S, .

NOTE: 1s stands for 1st stage cooking.

2. Turn the **Menu/Time** dial to adjust the cooking time until the LED display shows **20:00**.
3. Press the  (**Menu/Time** dial) to confirm and start cooking.
4. Press the **Stop/Cancel** button once to stop and hold the cooking. The LED display will show . Press again to cancel the setting.

Power Level Button Control (For Microwave Cooking)		
Order	LED Display	Microwave Power
1	 100%	100%
2	 80%	80%
3	 60%	60%
4	 40%	40%
5	 20%	20%
6	 00%	Fan only

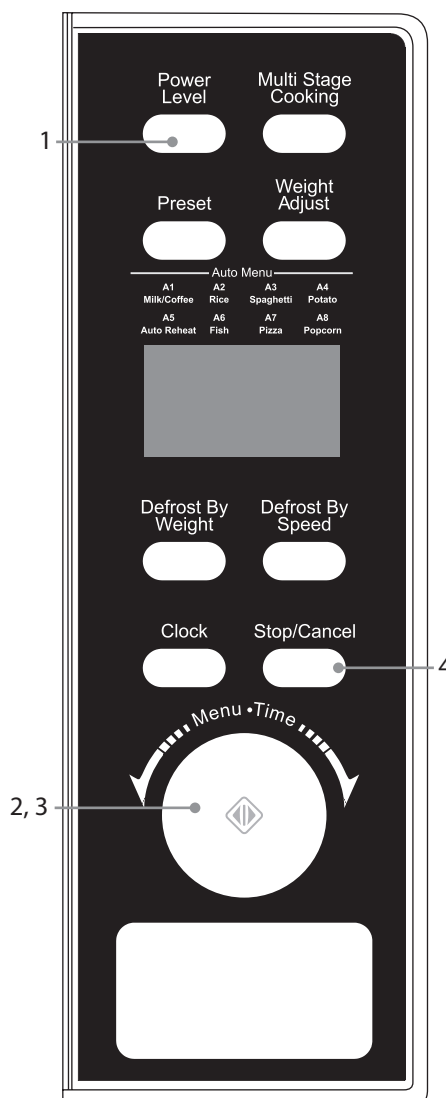





Two-Stage Cooking



For **Two-Stage Cooking**, please follow the steps below.

For instance: If you want to cook your food with 100% microwave power for 5 minutes and then to cook it with 80% microwave power for 7 minutes.

NOTE: You can only set 2 stages for Two-Stage Cooking. Neither defrosting programmes nor auto menu programmes can be set in Two-Stage Cooking.

1. Press the **Power Level** button to initiate the two-stage cooking with 100% microwave power as the first stage. The LED display will show 100%, , 1S, .
2. Turn the **Menu/Time** dial to adjust the cooking time until the LED display shows 5:00.
3.
 - a Press the **Multi Stage Cooking** button once and the LED display will show 100%, , 2S, .
 - b Then, press the **Power Level** button to change the second stage power level from 100% to 80%.

NOTE: 1S stands for 1st stage cooking.
2S stands for 2nd stage cooking.

4. Turn the **Menu/Time** dial to adjust the cooking time until the LED display shows 7:00.
5. Press the  (**Menu/Time** dial) to confirm and start cooking. The microwave will sound once to indicate it has started the defrosting count down. The microwave will sound again as it starts the microwave cooking (the second stage). Once completed, the microwave will sound five times and the LED display will show **End** to indicate the completion.
6. Press the **Stop/Cancel** button once to stop and hold the cooking. The LED display will show . Press again to cancel the setting.

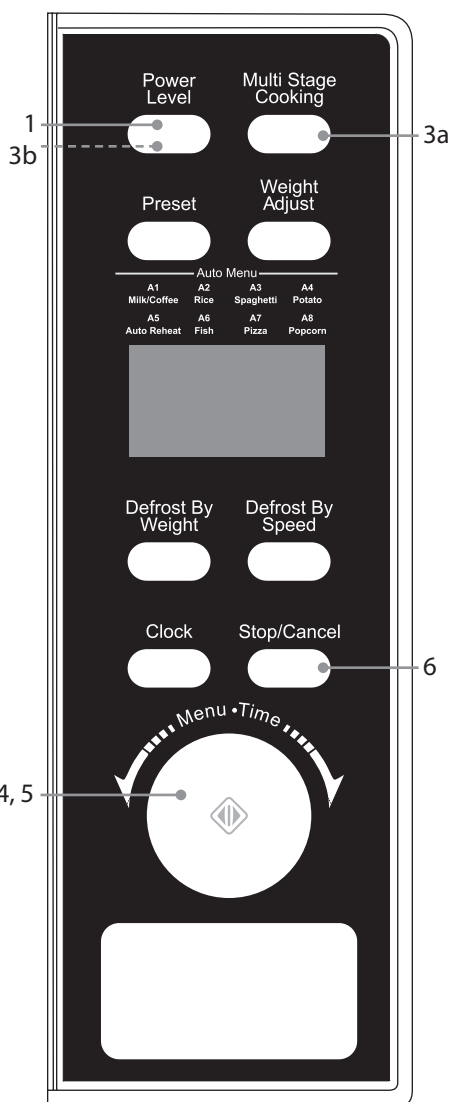





Operating Instructions

Delay Start Cooking (Programme Set in Advance)

For **Delay Start Cooking**, follow the steps below.

For instance: The current time is 12 o'clock (noon) and you want to cook with 80% microwave power for 5 minutes in 1 hour and 30 minutes time.

NOTE: You can only set 2 stages for Delay Start Cooking. Neither defrosting programmes nor auto menu programmes can be set in Delay Start Cooking. Ensure the oven door is closed prior to setting the program.

1. Press the **Power Level** button once and the LED display will show 100%, , 1S, . Press the button again to change the microwave power level to 80%, , 1S, .

2. Turn the **Menu/Time** dial to adjust the cooking time until the LED display shows 5:00.

ATTENTION: Do not press the  (Menu/Time dial) at this point.

3. a Press the **Preset** button to preset the starting time for the cooking. The hour figure will flash first.

b Turn the **Menu/Time** dial to adjust the starting time until the LED display shows 13:00.

4. a Press the **Preset** button to preset the starting time for the cooking. The minute figure will flash first.

b Turn the **Menu/Time** dial to adjust the starting time until the LED display shows 13:30.

5. Press the  (Menu/Time dial) to complete the setting. The microwave will sound 3 times when the count down reaches the starting time and cooking will start automatically.



6. To cancel the delay start cooking, press **Preset** button and then press the **Stop/Cancel** button.





Auto Cooking

This feature allows you to cook most of your food based on the food category and the weight. Select the category and choose the default weight of the food. For quick reference of the cooking time and the default weight, please refer to the **Auto Menu** table.

Auto Menu

1. Turn the **Menu/Time** dial in anti-clockwise to select the Auto Menu program required. The LED display will show **AUTO 8, 7, 6**, etc.
2. Press the **Weight Adjust** button to choose the default weight for your chosen program. Please refer to the Auto Menu table for information.
3. Press the  (**Menu/Time** dial) to confirm and start cooking.
4. Press the **Stop/Cancel** button once to stop and hold the cooking. The LED display will show . Press again to cancel the setting.

For instance: If you want to cook 400g of fish using the Auto Menu program, please follow the steps below.

- a. Turn the **Menu/Time** dial in anti-clockwise to select Auto Menu program for fish. The LED display will show **AUTO 6**.
- b. Press the **Weight Adjust** button until the LED display shows **400**.
- c. Press the  (**Menu/Time** dial) to confirm and start cooking.
- d. Press the **Stop/Cancel** button once to stop and hold the cooking. The LED display will show . Press again to cancel the setting.

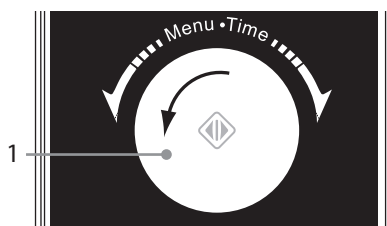
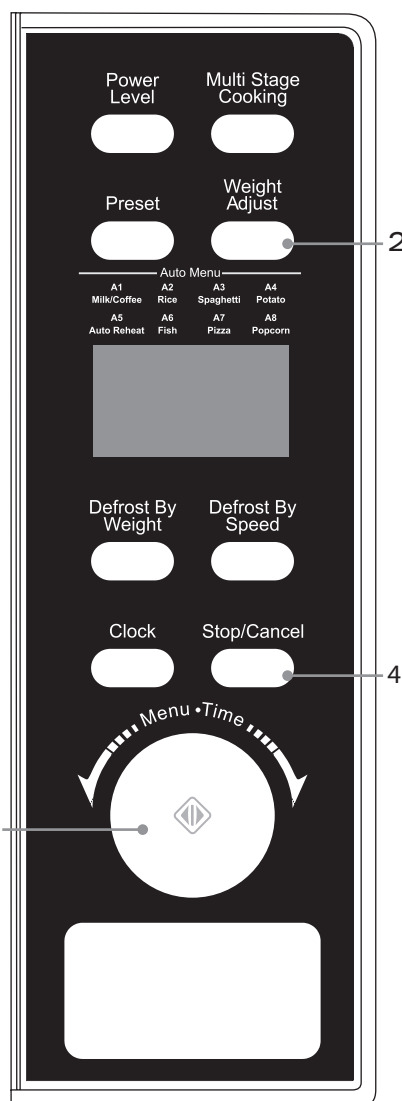



NOTE: The density and thickness of food can affect its cooking time. Ensure all food is piping hot and cooked thoroughly before serving. It is essential that food is checked during and after the recommended cooking time, even if Auto Menu was used.

Auto Menu table

Menu	Weight	Display	Cooking Time	Comments
AUTO 1 Milk / Coffee	200ml	1	1'30"	<ul style="list-style-type: none"> Only use suitable microwavable containers and cling film in the microwave oven. Pierce the film with a fork before cooking. The preset cooking time is designed for 200ml per cup.
	400ml	2	2'40"	
	600ml	3	3'50"	
AUTO 2 Rice	150g	150g	19'00"	<ul style="list-style-type: none"> Only use suitable microwavable containers and cling film in the microwave oven. Pierce the film with a fork before cooking. Ensure to check the cooking regularly to make sure the water does not boil over.
	300g	300g	22'00"	
	450g	450g	25'00"	
	600g	600g	28'00"	
AUTO 3 Spaghetti	100g	100g	22'00"	<ul style="list-style-type: none"> Only use suitable microwavable containers and cling film in the microwave oven. Pierce the film with a fork before cooking. Ensure to check the cooking regularly to make sure the water does not boil over.
	200g	200g	27'00"	
	300g	300g	32'00"	
AUTO 4 Potatoes	230g	1	5'00"	<ul style="list-style-type: none"> For best results, pierce the potatoes' skin before cooking. Once the potatoes are cooked, wrap them in aluminium foil for at least 5 minutes to ensure they are cooked thoroughly. The preset cooking time is designed for 230g per each potato.
	460g	2	9'00"	
	690g	3	13'00"	
AUTO 5 Auto reheat	200g	200g	1'30"	Make sure food is cooked thoroughly before consuming. Additional cooking time may be required for thicker pieces.
	300g	300g	2'00"	
	400g	400g	2'30"	
	500g	500g	3'00"	
	600g	600g	3'30"	
	700g	700g	4'00"	
	800g	800g	4'30"	
AUTO 6 Fish	200g	200g	3'00"	Make sure food is cooked thoroughly before consuming. Additional cooking time may be required for thicker pieces of fish.
	300g	300g	4'20"	
	400g	400g	5'40"	
	500g	500g	7'00"	
	600g	600g	8'20"	
AUTO 7 Pizza	150g	150g	0'50"	This setting is designed for re-heating cooked pizza slices (not frozen pizza). Additional cooking time may be required for thicker pieces of pizza.
	300g	300g	1'20"	
	450g	450g	1'50"	
AUTO 8 Popcorn	99g	99g	2'30"	For best results, we recommend using ready mix packed popcorn. Cover it with microwavable lid.

Quick Start Cooking

This feature allows you to quickly cook your food for 1 minute with 100% microwave power. Please follow the steps below.

1. Press the  (**Menu/Time dial**) to start the quick start cooking. Press the button again to add another 30 seconds. You may increase the cooking time up to 10 minutes.
2. a Alternatively, you can turn the **Menu/Time dial** clockwise to set the cooking time with 100% microwave power first.
b Then, press the  (**Menu/Time dial**) to start the quick start cooking.

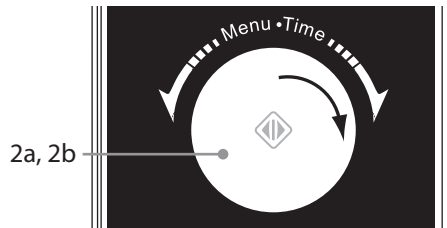
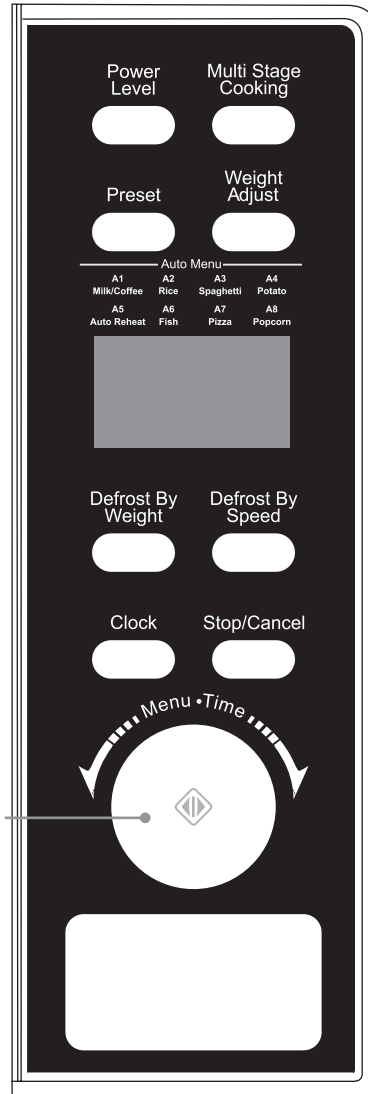

Defrosting

This feature allows you to defrost your frozen foods simply by entering the weight or time. You may wish to place the frozen food on a microwave safe plate or dish before placing it on the defrost rack (**not supplied in this microwave package**). This is to ensure that any liquids released during defrosting will not spill and dirty the interior of the oven.

Defrost by weight

1. Press the **Defrost By Weight** button once and the LED display will show **★ ★**, **AUTO**.
2. Press the **Weight Adjust** button to adjust the weight of your food. The default range is 100g to 1800g.
3. Press the **Menu/Time dial** to start defrosting.

TIPS: Large items may be frozen in the centre. Therefore, to ensure even thawing, turn them over from time to time and break them into smaller pieces during defrosting.

The oven will sound and pause after 2/3 running time. Open the oven door and rotate the food. You need to press the **Menu/Time dial** to restart defrosting.

Place roasts fat-side down or whole poultry breast-side down.

Drain liquids during defrosting as the juices from food can get hot and cook the food.

4. Press the **Stop/Cancel** button once to stop and hold the defrosting. The LED display will show **◇**. Press again to cancel the setting.

Defrost by time

1. Press the **Defrost By Speed** button once and the LED display will show **★ ★**.
2. Turn the **Menu/Time dial** to set the defrosting time.
3. Press the **Menu/Time dial** to start defrosting.
4. Press the **Stop/Cancel** button once to stop and hold the defrosting. The LED display will show **◇**. Press again to cancel the setting.

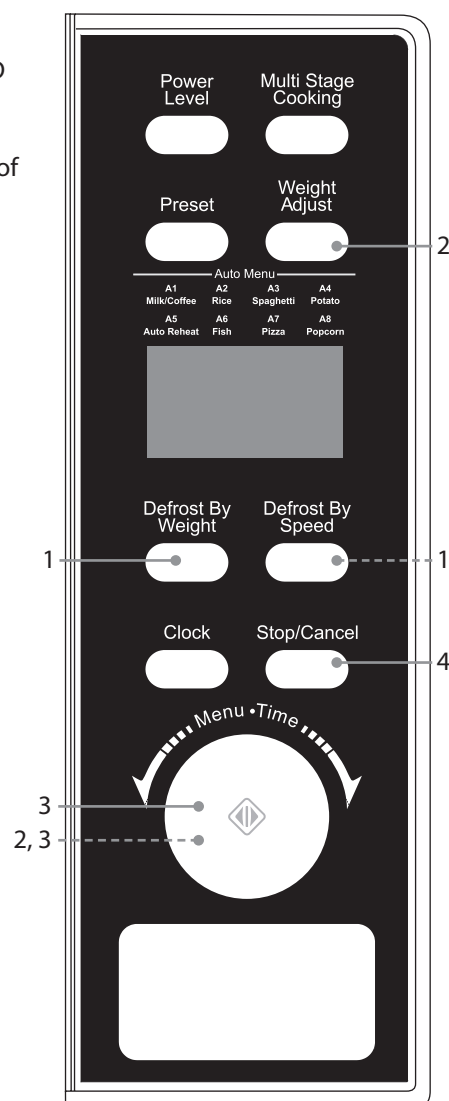

Querying the Cooking Function

This feature allows you to check and view the current power, time and pre-set time of your selected cooking program.

To find out the current cooking power

1. Press the **Power Level** button once and the LED display will show the current cooking power while the oven is in microwave cooking. However, this function will not be working in Defrost by Weight, Defrost by Speed and Auto Menu cooking. It will last for 3 seconds and then return to its original display.

To find out the time

2. Press the **Clock** button once and the LED display will show the time while the oven is in either microwave, combination, or auto menu cooking. It will last for 3 seconds and then return to its original display.

To find out the pre-set time

3. While the oven is still in the pre-set state, press the **Preset** button once and the LED display will show the pre-set time. It will last for 3 seconds and then return to its original display.

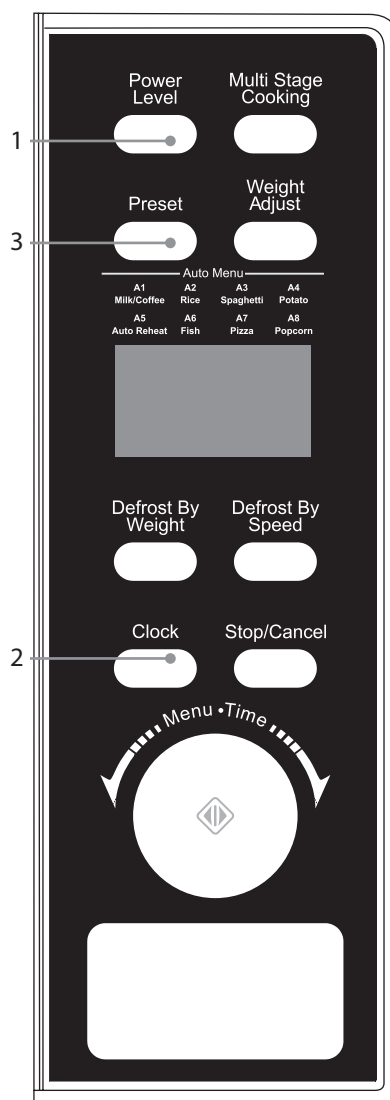

Operating Instructions

Cleaning Your Microwave

Cleaning your microwave each time you use it will help to prevent a build up of stubborn marks that can be difficult to clean.

Unplug your microwave from the mains and wait for it to cool down completely before cleaning.

On the right hand side wall of the cavity is the wave guide cover, microwaves are passed through this to enable your food to cook. It is important that this wave guide cover is kept clean at all times. Wipe it with mild detergent and water and leave to dry.

The oven walls have a special enamel coating which makes cleaning very easy. Use a soft damp cloth to wipe off any splashes or a paper towel to mop up any spills. Wipe off grease with a damp cloth and a little detergent. Dry thoroughly. As with any oven, if grease is left to accumulate, it can smoke and even catch fire.

Make sure you keep the outlet grids clean.

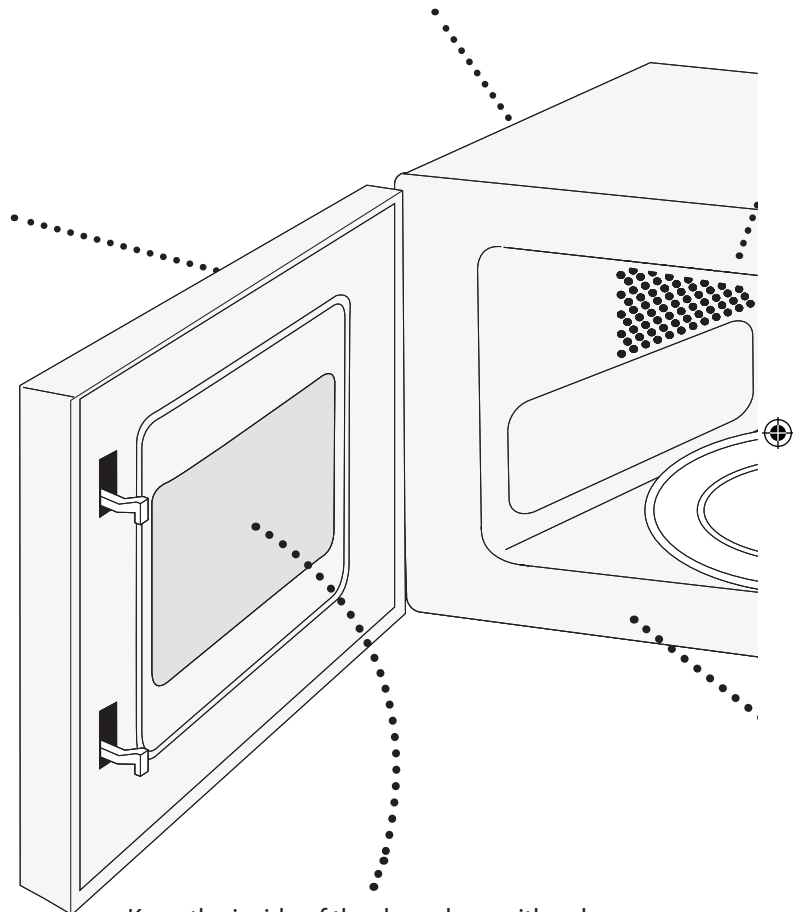

Keep the inside of the door clean with a damp cloth. Use warm soapy water for stubborn marks and dry thoroughly.

The inside of the door has a special coating and must not be cleaned with abrasive pads or cleaning powders.

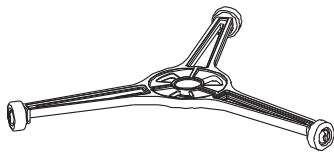
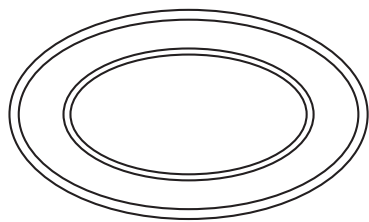

Treat the glass turntable as you would any glass plate. After you have used it for more than 15 minutes, allow it to cool down before you use it again. Do not wash the turntable in very hot water, this could crack it.

Make sure the turntable is dry before you put it back in the oven.

GB-26

Be careful not to spill water into the vents.

Keep the front of the oven clean so that the door can close properly.

Do not remove wave guide cover: It is important to keep the cover clean in the same manner as the inside of the oven. If grease is left to accumulate, it can smoke and even catch fire.

Unplug the oven before cleaning the power lead and the oven.
Wipe with a damp cloth and leave to dry before plugging it back in.

Clean behind the door ledge.

Use warm soapy water to clean the outside of the oven. Do not use abrasive pads or powders that could scratch the surface.

NOTE: Do not remove any fixed parts from the inside of your microwave oven during cleaning or at any other time.

Frequently Asked Questions

If a problem does occur, it may often be due to something very minor. The following Q & A may be able to resolve the problem.

Questions	Answers
Why doesn't the food seem to cook?	Check that: <ul style="list-style-type: none">• the cooking time has been set• the door is closed• the power socket is not overloaded causing the fuse to blow.
Why does the food seem undercooked or overcooked?	Check that: <ul style="list-style-type: none">• the correct cooking time has been set• the correct power setting has been used.
How can I stop eggs from popping?	When you bake or poach eggs in the microwave, the yolk can sometimes pop as steam builds up inside it. You can stop the egg from popping by piercing the yolk with a toothpick before cooking. Never cook eggs that are still in their shells.
Why is it so important that I allow standing time after cooking?	With microwave cooking, many foods build up enough heat inside them to continue cooking even after they've been taken out of the microwave. Because microwave cooking works from the outside of food inwards, standing time lets you cook the centre of the food without the outside being overcooked.
Why does my microwave sometimes take longer to cook than it says in the recipe?	First check that the microwave was set just as the recipe said. Cooking times and heat settings are suggestions to help prevent overcooking but differences in the weight, size, shape and starting temperature of food will all affect how long it takes to cook – just as it does with a conventional microwave. Use your judgement along with the recipe to check whether the food has been cooked properly.
Why do I get condensation on the inside of the door?	Condensation is perfectly normal, especially when you are cooking food with a high moisture content such as potatoes.
Does the microwave energy get through the window on the door?	No. The door has a special metal screen with holes in that lets you see inside but stops microwave energy from getting out.
Steam comes out of the side of the door and vents. Can microwave energy get out too?	No. The door and vents are carefully designed to let steam out during cooking but keep microwave energy in. The gaps are not big enough for microwave energy to escape.

Questions	Answers
What happens if the microwave is switched on while the oven is empty?	The microwave will be damaged. Do not switch the microwave on when there's nothing inside the oven. It is a good idea to keep a cup of water in the oven just in case someone accidentally starts the microwave.
Why doesn't the microwave's light illuminate?	Open the door. If the light does not illuminate, the bulb has probably blown. Call a qualified technician – do not try to change the bulb yourself.
There are sparks inside the microwave when I use the microwave. Will this cause any damage?	Yes. Make sure that you are not using any metal utensils and that your containers don't have a metal trim. You must not use metal in your microwave when you cook (except aluminium foil).
Light is showing through the vents and door. Does this mean the microwave energy can escape?	No. It is normal for the light to be visible and is nothing to be concerned about.
Why do I get interference on my TV and radio when I use the microwave?	Microwave ovens use radio waves similar to those received by TVs and radios. You can lessen the interference by moving your microwave further away from the TV or radio.

Specification

Input	230 - 240V ~50Hz
Output	700 - 800 Watts
Microwave Frequency	2450MHz
Outside Dimensions	452mm x 369mm x 262mm (width x deep x height)
Power consumption	
Microwave	1250 - 1350 Watts

Complies with EEC directives 89/336/EEC and 92/31/EEC.

Because we continually strive to improve our products, we may change specifications without prior notice.



This symbol on the product or in the instructions means that your electrical equipment should be disposed at the end of life separately from your household waste. There are separate collection systems for recycling in the EU.

For more information, please contact the local authority or your retailer where you purchased the product.



Visit Partmaster.co.uk today for the easiest way to buy electrical spares and accessories. With over 1 million spares and accessories available we can deliver direct to your door the very next day. Visit www.partmaster.co.uk or call 0870 6001 338 (UK customers only) Calls charged at National Rate.

NOTE: If you require a replacement for any of the items listed below, please quote their corresponding part numbers:	
Replacement Part	Part Number
Glass Turntable	XGALS20MB10P12
Turntable Ring	XGALS20MB10P11
Instruction Manual	XGALS20MB10B04



DSG Retail Limited is responsible for after sales service. If you have a query about the product please contact our product support line 0844 561 6263 (Currys) and 08700 118 117 (Pixmania).

DSG Retail Limited • Maylands Avenue
Hemel Hempstead • Herts • HP2 7TG • England

